

LETHAL IN DISGUISE

THE HEALTH CONSEQUENCES OF
CROWD-CONTROL WEAPONS

PHR

Physicians for
Human Rights

INCLO

INTERNATIONAL NETWORK OF
CIVIL LIBERTIES ORGANIZATIONS



ABOUT PHR

For 30 years, Physicians for Human Rights (PHR) has used science and medicine to document and call attention to mass atrocities and severe human rights violations. PHR is a global organisation founded on the idea that health professionals, with their specialised skills, ethical duties, and credible voices, are uniquely positioned to stop human rights violations. PHR's investigations and expertise are used to advocate for the protection of persecuted health workers, to prevent torture, document mass atrocities, and hold those who violate human rights accountable. In 1999, PHR led the effort to develop the internationally recognised guidelines on the Effective Investigation and Documentation of Torture and Other Cruel, Inhuman, or Degrading Treatment or Punishment, known as the Istanbul Protocol.

PHR has assessed the health effects of crowd-control weapons (CCWs) in a number of places, including Bahrain, Egypt, the Occupied Palestinian Territory (OPT), South Korea, Thailand, and Turkey. PHR studies have documented severe injuries due to birdshot and rubber bullets in Panama and OPT, abuse of tear gas posing risks to health in Bahrain, South Korea, and Turkey, and beatings using batons and sticks. Through direct examination of victims, desk research, and scientific evaluation of weaponry and its potential consequences (both when used appropriately and inappropriately), PHR has brought relevant information to advocates and policy-makers seeking to curtail responses by police and security forces that not only suppress lawful dissent, but also harm human health.



ABOUT INCLO

The International Network of Civil Liberties Organizations (INCLO) is comprised of 11 independent, national human rights organisations working to promote fundamental rights and freedoms by supporting and mutually reinforcing the work of the member organisations working in their respective countries, and by collaborating on a bilateral and multilateral basis. The members of INCLO are: the American Civil Liberties Union (ACLU), the Association for Civil Rights in Israel (ACRI), the Canadian Civil Liberties Association (CCLA), Centro de Estudios Legales y Sociales (CELS) in Argentina, the Egyptian Initiative for Personal Rights (EIPR), the Human Rights Law Network (HRLN) in India, the Hungarian Civil Liberties Union (HCLU), the Irish Council for Civil Liberties (ICCL), the Kenya Human Rights Commission (KHRC), the Legal Resources Centre (LRC) in South Africa, and Liberty in the United Kingdom. Each organisation is multi-issue, multi-constituency, domestic in focus, and independent of government, and advocates on behalf of all persons in its country through a mix of litigation, legislative campaigning, public education, and grassroots advocacy.

Police brutality and social protest are priority areas for INCLO. INCLO members have partnered to advocate against government and police repression of social protests and human rights activism. INCLO also seeks to promote and protect the right to protest by combining technical work – compilation of standards and analysis – with the creation of material intended for a wider audience. In 2013, INCLO published its first report, “Take Back the Streets: Repression and Criminalization of Protest around the World.” The report compiles case studies describing how police have responded to social protests in dissimilar political contexts. At the same time, it draws out common trends and underlying problems that exist around the world and, in doing so, highlights opportunities to influence legal processes at the international and national levels.

The current report has been a collaborative effort between PHR and 10 members of INCLO. The organisations that participated in the elaboration of this report are the ACLU, ACRI, CCLA, CELS, EIPR, HCLU, HRLN, ICCL, KHRC, and LRC. Liberty is not an author or party to the report.

TABLE OF CONTENTS

EXECUTIVE SUMMARY	6
ACKNOWLEDGMENTS	10
1. INTRODUCTION	13
2. BACKGROUND	17
3. CROWD-CONTROL WEAPONS AND THEIR IMPACT ON HEALTH	21
4. CONCLUSION AND RECOMMENDATIONS	89
ENDNOTES	96

3.1	KINETIC IMPACT PROJECTILES	22
	Egypt: The Case of Shaimaa' El-Sabbagh, Killed by Birdshot.....	28
	South Africa: The Death of Andries Tatane.....	32
	Israel: The Prohibition of Rubber-Coated Bullets.....	35
	Argentina: Police Use of Rubber Bullets at the Borda Hospital.....	36
3.2	CHEMICAL IRRITANTS	38
	Kenya: #OccupyPlayground – Excessive Force in the Quelling of a Public Demonstration at Langata Road Primary School.....	46
	Egypt: The Case of the Abu Zaabal Police Van.....	50
	Hungary: Police Attack on Protesting Refugees.....	52
3.3	WATER CANNONS	54
	Israel: The Skunk – a Humiliating Weapon.....	58
	England: The Campaign against Water Cannons.....	61
3.4	DISORIENTATION DEVICES	62
	Canada: Stun Grenade Blinds Student Protester.....	66
	South Africa: The Use of Stun Grenades at Marikana.....	69
3.5	ACOUSTIC WEAPONS	70
	Acoustic Weapons in the United States: From the G20.....	74
	Summit to the Black Lives Matter Protests	
	Canada: Authorising the Use of LRADs at the G20 Summit.....	77
3.6	DIRECTED ENERGY WEAPONS	78
	United States: Militarised Police Response to Protests in Ferguson, Missouri.....	84

EXECUTIVE SUMMARY

In recent years, there has been a rise in the number of popular protests in which people have taken to the streets to express grievances and claim their rights. In many cases, police and security forces have responded in ways that profoundly undermine the fundamental rights to freedom of peaceful assembly and freedom of expression, often leading to escalations in violence through unwarranted, inappropriate, or disproportionate uses of force. Law enforcement throughout the world is increasingly responding to popular protests with crowd-control weapons (CCWs). The proliferation of CCWs without adequate regulation, training, monitoring, and/or accountability, has led to the widespread and routine use or misuse of these weapons, resulting in injury, disability, and death. There is a significant gap in knowledge about the health effects of CCWs and an absence of meaningful international standards or guidelines around their use. As a result, the International Network of Civil Liberties Organizations (INCLEO) and Physicians for Human Rights (PHR) partnered to document the health consequences of CCWs and examine their roles and limitations in protest contexts and make recommendations about their safe use.

This report aims to raise awareness about the misuse and abuse of CCWs, the detrimental health effects that these weapons can have, and the impact of their use on the meaningful enjoyment of freedom of assembly and expression. We also seek to foster a global debate to develop international standards and guidelines. Ultimately, our goal is to prevent injury, disability, and death by providing information about CCWs and insisting on their safe use.

The misuse of CCWs and the human rights concerns that arise from this misuse are the result of a number of factors, the most significant of which are: gaps in international standards and regulations; insufficient testing, training, and regulations; a rapidly-growing industry; and a lack of accountability.

There are many flagrant examples of the misuse of CCWs, some of which are documented in case studies included in this report. In Kenya,

five children and one police officer were injured in a stampede resulting from tear gas being fired directly at schoolchildren protesting the seizure of a playground. In the United States, police intervention in the Black Lives Matter protests included the indiscriminate use of tear gas, disorientation devices, acoustic devices, beanbag rounds, and rubber bullets. In Egypt, a police officer was caught on video deliberately firing pellets at protesters' upper bodies in order to maximise injury. These troubling case studies, and others, are included throughout this report to put the medical evidence into context.

The report examines six kinds of CCWs used internationally: kinetic impact projectiles (KIPs), chemical irritants, water cannons, disorientation devices, acoustic weapons, and directed energy devices. The health effects of kinetic impact projectiles and chemical irritants are described in significant detail; these are the two weapon types about which there is a critical mass of data to analyse. The following systematic reviews evaluated published and grey literature released between January 1, 1990 and March 31, 2015.

KINETIC IMPACT PROJECTILES: The findings of a systematic review of medical literature indicate that KIPs cause serious injury, disability, and death. Our study identified 1,925 people with injuries from KIPs; 53 of these individuals died from their injuries and 294 suffered permanent disabilities. Of the injuries, 70 percent were considered severe. The data demonstrates that severe injuries are more likely when KIPs are fired at close range; some types of KIPs have the same ability to penetrate the skin as conventional live ammunition and can be just as lethal. When launched or fired from afar, these weapons are inaccurate and strike vulnerable body parts, as well as cause unintended injuries to bystanders. Therefore, there are significant doubts that these weapons can be used in a manner that is simultaneously safe and effective.

CHEMICAL IRRITANTS (commonly referred to as "tear gas") include a variety of chemical compounds intended to irritate the senses. The general perception is that these weapons have mostly short-term effects that include

irritation of the eyes, dermal pain, respiratory distress, and the psychological effects of disorientation and agitation. A systematic review of medical literature documenting the health effects of chemical irritants identified 5,131 people who suffered injuries; two of these people died and 70 suffered permanent disabilities. Out of 9,261 documented injuries, 8.7 percent were severe and required professional medical management, 17 percent were substantial, and 74.2 percent were minor. In a number of instances of injury, and in one of the two documented deaths, the canister that contains the gas form of chemical irritants was the cause of injury or death. The canisters caused traumatic injuries to the head, neck, and torso, as well as neurovascular injuries to the extremities. Eye injuries from the canister all led to permanent vision loss, most often from globe rupture. While chemical irritants are often thought of as causing minimal transient harm, the findings identify concerning levels of morbidity and even instances of death caused by these weapons.

Although significant medical literature on the health effects of water cannons, disorientation devices, acoustic weapons, and directed energy weapons is not available, case studies involving these weapons demonstrate their capacity for causing significant harm to protesters.

WATER CANNONS are inherently indiscriminate, particularly at long distances. Practically, they can make communicating with protesters very difficult, and their intimidating size and appearance may cause panic and lead to stampedes amongst protesters. The use of coloured dyes or malodorants in conjunction with a water cannon is a form of collective punishment that serves to highlight the potential for abuse of these weapons.

DISORIENTATION DEVICES, also known as flash-bang or stun grenades, create a loud explosion and/or a very bright flash of light. They are made of both metal and plastic parts that may fragment during the explosion, and therefore carry risks of blast injuries. Explosions that occur from close proximity can lead to amputation, fractures, and other serious injuries. There are frequent news reports and

anecdotal evidence of injuries and deaths from these weapons, including reports of injuries to military, corrections, and police officers while handling the devices. These weapons have no place in effective crowd management, intervention, and control.

ACOUSTIC WEAPONS, sometimes called sound cannons or sonic cannons, emit painful, loud sounds that have the potential to cause significant harm to the eardrums and delicate organs of the ears, and may cause hearing loss. There is little medical literature on the effects of these weapons; serious questions remain about their safety and efficacy in crowd-control contexts.

DIRECTED ENERGY WEAPONS are electromagnetic heating devices that deliver very high-frequency millimetre wavelength electromagnetic rays that heat skin on contact and cause a painful, burning sensation. These have not been used in practice, and there has been no assessment of their safety in crowd-control settings. Existing information identifies concerns about tissue injury, particularly with prolonged exposure or exposure to vulnerable organs such as the eye. Moreover, there are practical concerns that the use of an invisible but very painful weapon could exacerbate mistrust of government forces.

INCLO and PHR believe that the use of CCWs in assemblies should be a last resort and must always meet the tests of proportionality, necessity, legality, and accountability. The fact that an assembly may be considered unlawful does not justify the use of CCWs. In any event, the explicit goal of any intervention in a protest situation should be to de-escalate the situation and promote and protect the safety and the rights of those present.

In light of the evidence gathered in this report, INCLO and PHR have proposed a number of recommendations about pre-deployment of weapons, deployment of weapons, and post-deployment. At the pre-deployment stage, our recommendations relate to weapon design, manufacture, trade, procurement, selection, testing, and training. Recommendations for the deployment and use of CCWs include guidelines specific to the six different types of weapons examined in this report. At the post-deployment stage, we make recommendations for ensuring medical assistance for those impacted by CCWs, and for obtaining accountability for the use of CCWs.

The purpose of the recommendations, which can be found in section 4, is to reduce injuries, disabilities, and death caused by CCWs, to encourage the creation of international guidelines for the use of CCWs, to ensure protection of the rights to freedom of assembly, association, and expression, and to develop safe practices for the occasions where these weapons are deployed.

Right: Riot police in Buenos Aires, Argentina use water to enter a cultural centre and end the occupation of one of the rooms, Sala Alberdi. The room was occupied for close to two months in protest after a the mayor announced that the centre would be closed. (March 12, 2013)





ACKNOWLEDGMENTS



The report was written by Rohini J. Haar, MD, MPH, research fellow, Human Rights Center, University of California, Berkeley, and clinical faculty, Department of Emergency Medicine, Highland General Hospital and Kaiser Medical Center, Oakland, California; and Vincent Iacopino, MD, PhD, medical director, Physicians for Human Rights, adjunct professor of medicine, University of Minnesota Medical School, and senior research fellow, Human Rights Center, University of California, Berkeley.

The primary editors of the report were Cara Zwibel (director, Fundamental Freedoms Program, CCLA), Anne Suciu (attorney, Human Rights in East Jerusalem Project, ACRI), Karim Ennarah (researcher on criminal justice and policing, EIPR), Luciana Pol (senior fellow security policy and human rights, CELS), and Lucila Santos (program coordinator, INCLO).

This report is based on research conducted by Rohini J. Haar, MD, MPH; Nikhil Ranadive, MS, medical student, Emory University; Vincent Iacopino, MD, PhD; Madhavi Dandu, MD, MPH, associate professor of medicine, UCSF; and Sheri Weiser, MD, MPH, associate professor of medicine, Division of HIV/AIDS and Center for AIDS Prevention Studies, UCSF.

INCLO is also grateful to Jennifer Turner (ACLU), Camila Maia (CELS), Marcela Perelman, (CELS), Manuel Tufró (CELS), Szabolcs Hegyi (HCLU), Pia Janning (ICCL), Andrew Songa (KHRC), and Michael Power (LRC) for their contributions and reviews to this report.

This report was also reviewed and edited by Physicians for Human Rights leadership and staff, including Donna McKay, MS, executive director; Widney Brown, JD, director of programs; DeDe Dunevant, director of communications; and Eliza B. Young, MA, former publications coordinator. It was edited and prepared for publication by Claudia Rader, MS, content and marketing manager.

This report has benefited from external review by Michele Heisler, MD, MPA, Physicians for Human Rights (PHR) volunteer medical advisor, PHR board member, and professor of internal medicine and health behavior and health education at the University of Michigan Medical School.

INCLO thanks Taryn McKay for design and photo editing and Marg Anne Morrison for copyediting.

INCLO is grateful to the Open Society Foundations and the Ford Foundation for their generous support of its work in this area.

PHR's research was funded with the generous support of the Open Society Foundations.



1.0

INTRODUCTION

Respect for freedom of expression and assembly is one of the key indicators of a government's respect for human rights¹, and one of the pillars of modern participatory democracy. When people exercising their freedom of expression challenge or criticise government, or demonstrations are organised to oppose government policy or leaders, or even powerful non-state actors, state respect for the exercise of these fundamental freedoms may rapidly decline. In recent years, there has been an increase in the number of popular protests in which people have taken to the streets to express grievances and claim their rights. These protests have swept across the globe, leaving no continent untouched. In many cases, police and security forces have responded in a manner that profoundly undermines fundamental human rights, including freedom of peaceful assembly and freedom of expression, among others – often leading to escalations in violence through unwarranted, inappropriate, or disproportionate uses of force. This trend is not exclusive to authoritarian governments; democratic governments have responded in a similar or problematic manner to acts of protest.

Crowd-control weapons (CCWs) have increasingly been used in the response by law enforcement^a to these popular protests, mainly through interventions consisting of large-scale crowd dispersal operations using these weapons indiscriminately. Also known as “riot-control weapons,” “non-lethal,” “less lethal,” or “less than lethal” weapons, CCWs include chemical irritants, kinetic impact projectiles, acoustic weapons, water cannons, stun grenades, electrical conduction devices, and directed energy weapons, among others. We employ the term “crowd-control weapons” (CCWs) to denote both the weapons being discussed and the context of their use that is being examined. CCWs

Left: A woman in the protest against the closure of Sala Alberdi tries to talk to the anti-riot unit police, March 12, 2013

^a Throughout this report, we use the term “law enforcement” to encompass a broad definition of police and security forces. In particular, we rely on the definition of “law enforcement officials” used in the Basic Principles on the Use of Force and Firearms by Law Enforcement Officials, which “includes all officers of the law, whether appointed or elected, who exercise police powers, especially the powers of arrest or detention. In countries where police powers are exercised by military authorities, whether uniformed or not, or by State security forces, the definition of law enforcement officials shall be regarded as including officers of such services.”

are marketed as devices that are less lethal than conventional weapons, aimed at minimising the risk of permanent injury or death while effectively maintaining public order. However, the use of these weapons in protests across the world has been shown to result in frequent injury, disability, and even death. In this regard, CCWs are often wrongly perceived by law enforcement agencies as being safe and not deadly, and they are therefore widely condoned for use to disperse demonstrations. We have seen many instances in which they are used as tools of political repression to deter, demoralise, intimidate, injure, and kill protesters rather than as tools for safer crowd management.

There are many flagrant examples of the misuse of CCWs. In 2015, five children and one police officer were injured in a stampede caused when tear gas was fired directly at schoolchildren at the #OccupyPlayground protest against the seizure of a playground by private developers in Kenya.² In 2014, in the Black Lives Matter protests in Ferguson, Missouri, United States, the police intervention included the indiscriminate use of tear gas, disorientation devices, acoustic devices, beanbag rounds, and rubber bullets, causing injuries to protesters and journalists covering these events.³ In 2013, rubber bullets were fired against protesters inside a psychiatric hospital in Argentina, causing serious injuries among journalists, legislators, hospital workers, and patients residing in the hospital. The infamous “Eye Sniper” case in Egypt in 2011, in which a police officer was caught on video deliberately firing pellets at the upper bodies of protesters in order to maximise injury, demonstrates the problems associated with kinetic impact projectiles.⁴ Other forms of misuse include the excessive deployment of tear gas canisters for several days or weeks at a time, and the use of tear gas in water cannons, among others.

These cases and others point to a growing trend of law enforcement using CCWs against crowds in inappropriate, unnecessary, and disproportionate ways, causing serious and even fatal injuries. However, there is very little information on how these weapons should be used and on their potential health impacts. Despite their long-standing presence, the use and misuse of these weapons, and

the health consequences thereof, have not been systematically studied or documented. Manufacturers provide limited information on the intended use of CCWs and their possible adverse health effects and most law enforcement agencies collect only limited information on use-of-force incidents involving CCWs. If they do collect data, it is rarely publicly available.

Against this background, the International Network of Civil Liberties Organizations (INCLO) and Physicians for Human Rights (PHR) have partnered to document the health consequences of CCWs. PHR applied its deep medical and scientific expertise to the systematic review of the published medical literature and produced an analysis of the weaponry and its potential consequences. INCLO, through its network of national civil liberties and human rights organisations, contributed its broad knowledge of police brutality, social protest issues, and on-the-ground human rights challenges.

The present report is the result of this partnership. It gathers and analyses the existing medical literature on CCWs in order to contribute to the significant gaps in knowledge and information on this issue. The report reviews different types of CCWs, how they work, and the impact of their use on human health. Each section includes case studies from INCLO member countries describing instances when CCWs have been utilised against protesters and/or during demonstrations.

METHODOLOGY AND LIMITATIONS

The findings in this report are based on research conducted by PHR from September 2014 to May 2015. PHR sought to triangulate expert field experience on the use of CCWs and the legal frameworks under which these weapons are used with medical literature on related injuries. First, PHR conducted a semi-structured survey among INCLO member organisations and other civil liberties and human rights experts. The survey identified the weapons commonly employed, assessed the conditions under which these weapons are used in different countries, and identified the key concerns of stakeholders. Second,

PHR conducted extensive research on six commonly used CCWs: chemical irritants, kinetic impact projectiles, acoustic weapons, water cannons, stun grenades, and directed energy weapons.^b Research topics included a history of the weapons' use, how they work, and an analysis of the harms produced by their use. Finally, PHR conducted a literature review of publications on the health impacts of these weapons published over the past 25 years and analysed all relevant data, including the severity of the injuries caused by the weapons and different factors affecting their severity.^c

A systematic review was conducted for the most commonly used weapons: chemical irritants and kinetic impact projectiles.^d Titles and abstracts of all identified articles were reviewed and several hundred full text articles were read to identify all injury data that met the inclusion criteria and that were of sufficient quality. Injury data from the selected studies (31 studies on chemical irritants and 24 studies on kinetic impact projectiles) was collected for analysis. For the other weapons categories, there is limited published data for review; in these cases, additional case-series analyses^e were used in documenting their health effects. Analysis was conducted with the understanding that the published literature does not document the entire scope of injuries from CCWs, but provides insight into the range of potential injuries.

The absence of a systematic reporting requirement for deaths and injuries in crowd-control settings makes it likely that the health outcomes in the medical literature and in case studies largely underestimate the prevalence

of deaths and injuries.

This report has multiple goals and objectives:

- To protect the rights to life (Art. 6), liberty and security of the person (Art. 9), dignity (Art. 10), and freedom of expression (Art. 19), assembly (Art. 21), and expression (Art. 22), as provided for in the International Covenant on Civil and Political Rights (1966);
- To raise awareness about the misuse and/or abuse of CCWs and the detrimental health effects that these weapons can have;
- To foster a global debate in order to develop international standards and guidelines and promote appropriate domestic state regulations on the proper use of CCWs;
- To promote the establishment of regulations for manufacturers; and
- Ultimately, to prevent injury, disability, and death by providing information and insisting on the safe use of CCWs.

This report is the first of which we are aware that closely examines the medical knowledge on the effects of CCWs; it also highlights how much is still not known, not reported, and not being studied in this area.

^b Tasers are one of the most commonly used less lethal weapons. However, they were not included in this study because while they have been deployed in protest contexts, they are generally used for the purposes of subduing and detaining an individual and not for the purposes of managing or controlling a crowd.

^c The injuries were classified as minor, moderate, or severe, based on the acuity and the resources required to manage that injury. Minor injuries were transient symptoms that may not have been present on physical exam or were expected side effects of the weapon (for example, lacrimation, mild respiratory distress, sore throat, or nausea caused by chemical irritants). Moderate injuries were those that were unexpected from previous published data on the weapon, were evident on physical exam, or lasted longer than expected, but may not have required health professional management (for example, persistent skin rashes, first-degree burns or persistent respiratory symptoms caused by chemical irritants). Severe injuries were injuries that required professional medical care (for example, lacerations requiring sutures, second- or third-degree burns, airway obstruction, or severe ocular trauma caused by chemical irritants). Injury data was only included if it was documented by a medical professional. Injuries reported by patients, without any documentation, were excluded.

^d A systematic review of the literature is a rigorous methodology to identify literature on a subject. The PHR team adhered to standard guidelines on the development of a systematic review protocol. PHR used multiple search engines to identify all possible relevant data on injuries and health impacts of CCWs.

^e This refers to review and analysis of compilations of injuries prepared by other groups, and found in other sources, including news reports, government reports, and medical literature.



2.0

BACKGROUND

In order to understand why crowd-control weapons are being misused in a manner that violates basic human rights, multiple factors must be considered. The most important factors that we have identified are: gaps in international standards and regulations; insufficient testing, training, and regulations; a rapidly growing commercial weapons industry; and lack of accountability.

GAPS IN INTERNATIONAL STANDARDS AND REGULATIONS

Unfortunately, international mechanisms have not kept pace with the rapid development of crowd-control technologies and techniques.⁵ International standards addressing the use of CCWs are very limited and there are no limitations on the kinds of weapons that may be used in demonstrations, or on the manufacture and trade of CCWs.⁶ The lack of evidence-based regulations on the use of CCWs is exacerbated by the relatively underdeveloped standards on: how to effectively police protests; how to isolate small pockets of protesters who may turn violent without resorting to the use of indiscriminate force; how to prevent escalation and confrontation between protesters and the police or security forces; and how to mitigate any harm or injury when it is necessary to use force – among other issues related to the policing of protests.

Most weapons conventions do not specifically deal with CCWs, and those that do mention CCWs do not provide necessary guidance and regulations as to their use. For example, although the Chemical Weapons Convention (CWC)⁷ prohibits the use of riot-control agents (RCAs) in warfare, their use is permitted for “Law enforcement including domestic riot control purposes ... as long as the types and quantities are consistent with such purposes.” Unfortunately, neither the CWC nor the Organisation for the Prohibition of Chemical Weapons clarify what restrictions are placed on the use of RCAs in riot settings, and the use of these agents is not included in current CWC monitoring and reporting practices.

Left: “Day of Rage” protest against the Israeli government plan to displace more than 40,000 Bedouin from the Negev (“Praver-Begin Plan”), Hura, Israel, November 30, 2013.

Existing international standards^f outline principles on police interventions, particularly on the use of force, and are applicable to social protests. However, these are not sufficient: while the United Nations Basic Principles on the Use of Force and Firearms by Law Enforcement Officials (“UN Basic Principles”)⁸ and the Code of Conduct for Law Enforcement Officials (“Code of Conduct”)⁹ provide some basic and general principles on the use of force, these standards are largely outdated and do not account for the rapid developments in crowd-control technology.⁸ The UN Basic Principles have also been criticised for lacking “clarity and precision, and that their broad provisions are not easily translatable into concrete, practical guidelines that can be readily applied at the domestic level.”¹⁰ In addition, they do not benefit from an official commentary, as does the Code of Conduct. As noted by the UN Special Rapporteur on extrajudicial, summary, or arbitrary executions, Christof Heyns: “Some of the principles are also redundant. It has been pointed out that the [UN] Basic Principles do not define concepts such as ‘force’ or ‘firearms’, and pose general standards, as opposed to concrete action guidelines.”¹¹

However, these standards, coupled with case law, do provide some limited guidance on the use of force. For example, any use of force must always be limited by the principles of necessity, proportionality, legality, and accountability.^h Further, all actions must aim to protect and preserve human life and dignity.¹² Moreover, before law enforcement officials resort to force when dealing with protests, they must attempt to use nonviolent means – such as presence, dialogue, information, and de-escalation. Another basic principle that is, unfortunately, too often violated during assemblies states that in the dispersal of assemblies, law enforcement officials shall avoid the use of force, or, where that is not practicable, shall restrict such force to the minimum extent necessary.¹³

In addition, the UN Basic Principles, which problematically refer to CCWs as “non-lethal weapons,” thereby failing to acknowledge their potential lethality, encourage states to adopt CCWs in order to enable a graduated response in the use of force and to offer a less injurious

alternative to more deadly equipment currently in use. However, these recommendations fall short of outlining appropriate guidelines for their use, including when and how to use, or not use, CCWs. In this regard, Resolution 25/38, adopted by the UN Human Rights Council in April 2014, went a little further on this issue by encouraging “States to make protective equipment and non-lethal weapons available to their officials exercising law enforcement duties, while pursuing international efforts to regulate and establish protocols for the training and use of non-lethal weapons.”¹⁴

In fact, this same resolution on promotion and protection of human rights in the context of peaceful protests acknowledges the gap on standards and guidelines on policing protests; it thus requests that the Special Rapporteur on the rights to freedom of peaceful assembly and of association, Maina Kiai, and the Special Rapporteur on extrajudicial, summary, or arbitrary executions, Christof Heyns, compile practical recommendations for the proper management of assemblies, based on best practices and lessons learned, and submit this compilation at the Council’s 31st session in March 2016. This initiative promotes the creation of stronger, detailed standards and guidelines on the use of force in the context of social protest, providing a unique opportunity for human rights and civil liberties organisations to make recommendations based on their years of monitoring violations of the right to peaceful assembly.

INSUFFICIENT TESTING, TRAINING, AND REGULATIONS

While CCWs may theoretically offer an option for reduced force, in practice, and perhaps because of the assumption that they are always less lethal, the weapons are often used in an indiscriminate manner, without exhausting all other possible peaceful means first. This is due, in large part, to inadequate pre-deployment testing, insufficient training, lack of regulations, and poor accountability mechanisms.

Training of law enforcement officials should include training not only on how to use CCWs but also on how to use these weapons

in the context of a demonstration, where conditions can be more adverse and sensitive. Crowd dynamics are often chaotic and law enforcement officials should be trained to deal with these conditions.

Regulations and operational guidelines or protocols are also an important aspect of good police practice. In principle, these may exist, but they may not be publicly available, may be outdated, and may lack provisions for newer CCW technologies. In other cases, no such regulations exist. Moreover, guidelines and standard operating procedures are often industry-driven and the people designing (and profiting from) weapons are the ones determining how they should or should not be used.

RAPIDLY GROWING COMMERCIAL WEAPONS INDUSTRY

While the absence of standards, guidelines, and regulations remains static, the supply and demand for CCWs continues to grow and expand. CCW development has spread across the globe during the last two decades and the number of companies that manufacture and trade in these weapons has greatly increased.¹⁵ While traditional manufacturers continue to develop CCWs (in France, Germany, Israel, the United Kingdom, and the United States), new companies are emerging globally, with production now occurring in more than 50 countries. The increase in the use of force during protests may be explained by the rapidly growing supply of CCWs, which makes weapons cheaper for various law enforcement units to purchase and then utilise with little provocation. As CCWs are becoming increasingly affordable, law enforcement units and governments are demanding more munitions, further expanding the market.¹⁶ In this regard, the report submitted by Christof

Heyns on April 1, 2014, notes that “the growing, largely self-regulated market of ‘less lethal weapons’ cannot solely determine policing weapons technology, especially when it could involve unacceptable human cost.”¹⁷

LACK OF ACCOUNTABILITY

An effective accountability mechanism is a key element in promoting appropriate crowd management techniques and the proportionate use of force by law enforcement. Unfortunately, in most cases, there are no efficient accountability mechanisms in place. Even in countries in which an external police oversight agency exists, it is usually too weak and lacks the necessary powers, resources, independence, and transparency to be effective.

The prosecution and conviction of law enforcement officials who use CCWs in an unlawful or excessive way is rare. In addition, there has been a dearth of administrative disciplinary measures taken against law enforcement officials who misuse CCWs. In South Africa, for example, there were 204 crowd-control-related complaints lodged against law enforcement between 2002 and 2011, but only 85 cases were investigated, and only one police officer was convicted.¹⁸ The perception of CCWs as non-lethal mechanisms results in weaker controls on their use: weapons and munitions registries are often not kept or they are concealed. In some cases, post-incident documentation is limited to recording munitions discharge, while detailed recording of incidents and of injuries is absent. Most of this information, if available, is concealed from the public or from independent experts and monitors. This renders accountability measures impossible or ineffective.

^f According to the Omega and Amnesty International report: “Restrictions on the use of force derive from the Convention against Torture (CAT) and the International Covenant on Civil and Political Rights (ICCPR), as well as in the BPUFF, the UN Code of Conduct for Law Enforcement Officials (CCLEO), and the UN Standard Minimum Rules for the Treatment of Prisoners (SMRs). Such treaties and standards play a key role in setting out universal guidelines for the use of weapons and restraints by police and correctional officers.”

^g The UN Basic Principles and the Code of Conduct were approved in 1990 and 1979, respectively.

^h The four basic principles are included in various national codes of conducts and standard operating procedures for police forces. The principle of necessity emphasises that use of force should always be considered an exceptional measure. Proportionality means that use of force must be proportionate to the lawful objective to be achieved and to the seriousness of the offence. Law enforcement agencies must ensure that their actions conform to national laws and regulations, and to international human rights standards, and that they are accountable through adequate reporting and review procedures.





3.0

CROWD-CONTROL WEAPONS AND THEIR IMPACT ON HEALTH

In this section, we will review six kinds of crowd-control weapons: kinetic impact projectiles, chemical irritants, water cannons, disorientation devices, acoustic weapons, and directed energy devices. For each type of weapon, we review the weapon profile (history and description of the device), the mechanism of action (how the weapon works), and the health effects. Case studies that demonstrate specific instances of use, misuse, or advocacy related to particular weapons are included in each section. Recommendations for each type of weapon are addressed in section 4.

Left: Palestinian protesters react to stun grenades thrown by Israeli forces during a “Day of Rage” protest against the Israeli government plan to displace more than 40,000 Bedouin from the Negev (“Prawer-Begin Plan”), Al Jalazun, West Bank, November 30, 2013.

3.1

KINETIC IMPACT PROJECTILES

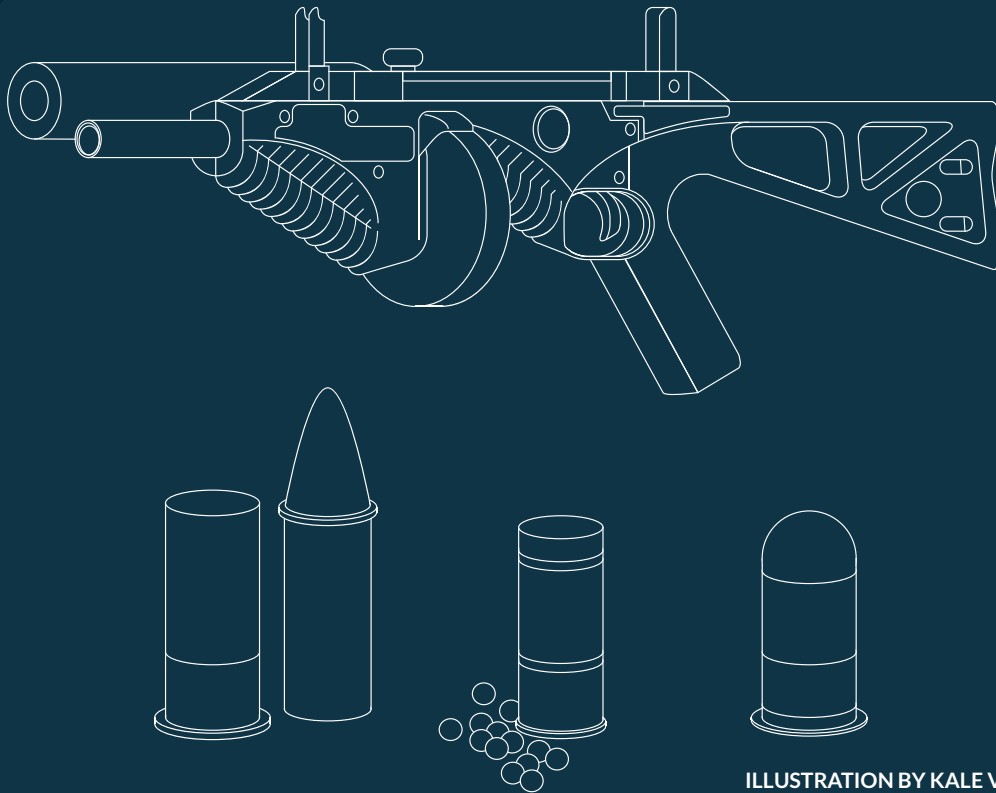

ILLUSTRATION BY KALE VANDENBROEK

WEAPON PROFILE

Kinetic impact projectiles (KIPs), often called rubber or plastic bullets, are regularly used in crowd-control settings around the world. These weapons, initially designed by the military, were developed in an effort to allow security and law enforcement personnel to keep physical distance between them and the individual or group they were trying to control.

Early forms of KIPs used in protests were sawed-off pieces of wooden broom handles that were shot at rioters in Singapore in the 1880s. In the 1960s, slightly more advanced wooden bullets were developed by British colonialists and used against protesters in Hong Kong, Malaysia, and Singapore. The British then developed first wooden, then plastic polyvinyl chloride (PVC) and rubber bullets for use in Northern Ireland. The United States began using rubber and plastic bullets during Vietnam War protests, but, after a fatality in 1971, halted their use in protest settings until the early 1980s,

when they were gradually reintroduced. Over the past 30 years, production of KIPs has spread from a few manufacturers in the United States and United Kingdom to dozens of producers throughout the world. Manufacturers now develop more than 75 different types of bullets and launchers in a variety of locations.¹⁹

Projectiles are made from combinations of rubber, plastic, PVC, various metals including lead and steel, wood, hard foam, and wax. Some bullets are designed to be fired as a single missile, while others are fired as a group of pellets. The latter are sometimes known as “shot,” where many small- to medium-sized pellets are fired at a broad target, or as “bean bag rounds,” where small lead pellets are stitched into a synthetic cloth bag. Newer weapons include projectiles with a hard outer shell coating tear gas or pepper spray that explodes upon impact, or “attenuated energy projectiles,” where a hollow tip can limit the risk of ricochet or penetration.

MECHANISM OF ACTION

A projectile weapon works by transferring kinetic energy (i.e., energy from movement) from a weapon into a person. KIPs are purportedly designed to inflict pain and incapacitate an individual without the projectile penetrating into the body; however, as described below, their use has resulted in serious injury, permanent disability, and, in some cases, death. The effect of the KIP will vary depending on the type of projectile and the type of launcher used; there is a wide variety of both in the general category of KIPs. Projectiles can be classified as high- or low-energy, flexible or non-flexible (rigid), single or multiple, direct- or indirect-fire, or by method of delivery. Those commonly used in crowd-control settings globally include: rubber bullets, plastic bullets, bean bag rounds, birdshot, buckshot, rubber-coated metal bullets, and sponge bullets.

The projectile's force depends on a number of factors, including its size and speed. In addition, the shape of the projectile, its ability to break apart, the number of projectiles fired at once, and the direction in which they are fired can all impact how the projectile functions. The projectile can be designed with a large surface area to reduce the chances of skin penetration, or as a lighter object that will quickly lose speed while in flight. A launcher or gun can propel the projectile at a certain speed or change its rotation or flight path to reduce its force on impact. However, some of these projectiles have muzzle velocities similar to that of live ammunition. As a result, close-range firing of a KIP results in injury patterns similar to those seen with live ammunition, causing severe injuries and disabilities. It is important to note that while factors such as a large surface area may reduce the risk of skin penetration, they increase the inaccuracy of the weapon. KIPs, therefore, are not only likely to be lethal at close range, but are likely to be inaccurate and indiscriminate at longer ranges, even those recommended by manufacturers for safety.



KIPs are intended to allow law enforcement or security personnel to gain control of a situation, or over an individual or group, while minimising the chance of death. The nature of the weapon and projectile is supposed to limit penetrating or life-threatening injuries; however, the designs that are required to slow down the projectile before it hits a person usually make the weapon less accurate. Unlike a traditional bullet, KIPs tend to be oddly shaped or large, which causes tumbling rather than direct forward movement. Put simply, while losing speed (to lessen the risk of penetrating injury) KIPs often also lose accuracy.

There is little or no published research on the safety of KIPs, how they were designed, or the type of safety testing they have undergone and under what conditions. Overall, there is a lack of transparency by the manufacturers. There are dozens of weapon types on the market, including projectiles and launchers, each with their own safety features and requirements. This variety of weapon types can generate considerable confusion about their proper use. Lack of transparency on the part of manufacturers also limits information that health care providers can use in assessing injuries.

KIPs are marketed to military, police, and private security forces in nearly every country, with little or no regulatory oversight or accountability. Guidelines on the use of KIPs, from police and military or by manufacturers, are not usually publicly available. Use-of-force guidelines that are available generally recommend that KIPs be used only for individual force-control rather than on groups of people. They also indicate that when KIPs are used, they should not target vital areas of the body, and, instead, should be aimed at the legs. Firing these weapons in the air or at the ground should also be avoided, as this could result in ricochet and lead to injuries. Evidence from photographs, video cameras, and testimonials in many countries identifies the frequent violation of these guidelines. There are examples of KIPs being aimed at the upper body or face, being fired from very short distances, being used against non-threatening individuals, and being fired indiscriminately at crowds.

Figure 1: Selected types of Kinetic Impact Projectiles*

KINETIC IMPACT PROJECTILES	ALTERNATIVE NAME(S)	COMPOSITION/DESCRIPTION	MECHANISM OF ACTION	RANGE AND USAGE
Rubber or Plastic Bullets.	Baton rounds. Riot rounds.	Solid, spherical or cylindrical projectiles of variable sizes made solely of hard rubber, plastic, or polyvinylchloride (PVC). May be fired as single shots or in groups of multiple projectiles within a cartridge.	Less dense than metal bullets to limit force on impact.	Intended to only fire at target's legs. Muzzle velocity and force on impact are dependent on variable shapes and fills within cartridges that can affect flight patterns.
Plastic-metal composite bullets.	(misleadingly called) plastic or rubber bullets.	A composite of plastic and metal fragments, or small shards of metal (lead or steel) within a rubber, plastic, or PVC base.	Have higher density than solid plastic but less than metal bullets. Designed to extend firing range or force on impact from traditional.	Intended to only fire at target's legs. Similar to solid baton rounds with higher speed and force on impact possible. Variable shapes can affect flight patterns and force on impact.
Rubber-coated metal bullets.	(misleadingly called) plastic or rubber bullets.	Spherical or cylindrical projectiles with solid lead or metal core surrounded by a 2 mm coating of plastic or rubber (Core weight: about 16 g; diameter: 15.75 mm). May be fired as single shot or in groups up to 15.	Outer coating made of rubber to limit penetrating trauma but dense metal core augments force on impact.	Intended to only fire at target's legs. Similar to solid baton rounds with higher speed and force on impact possible. Primarily used in the Occupied Palestinian Territory by Israeli army.
Flexible baton round.	Bean bag rounds.	Synthetic cloth bag filled with about 45 g of small metal pellets (100 pellets of #9 lead shot is most common). Greatest diameter for the bag is usually 6 cm.	A cartridge has wadding meant to expand and drop the wadding as it travels, creating a wider surface area blow.	Intended to only fire at target's legs. Expansion of the bag is problematic at short distances leading to injuries.
Sponge rounds.	Foam rounds. Sponge grenade. Plastic-tipped bullet.	Projectile with a hard foam nose and a high density plastic body. Fired from a grenade launcher specific for these projectiles.	Large surface area and soft tip intended to limit penetrative injury.	Minimum engagement range is 10 – 15 m, and maximum effective range is 50 m. Designed as “direct fire” at target's less vulnerable anatomy (legs).
Pellet rounds.	Buckshot/ birdshot.	Cartridges filled with small lead, steel, or plastic/rubber pellets that disperse/spread out when fired. Birdshot consists of hundreds of smaller pellets (1.27 mm – 4.57 mm); buckshot ranges from 5 mm to 25 mm and may require stacking in a fixed geometric arrangement.	Smaller pellets may have wider dispersal patterns and less accurate aim; larger pellets may have higher kinetic energy.	Causes an indiscriminate spray of ammunition that spreads widely and cannot be aimed.
Attenuated Energy Projectile (AEP).	AEP.	Hard plastic body and a hollow nose.	Hollow tip is designed to collapse on impact, limiting penetrative injury.	Intended to only fire at target's legs. Specific weapon used primarily in the UK.

*Note: this table is not comprehensive and only includes some common types of KIPs and data gleaned from accessible sources (manufacturer data is commonly unavailable)

“KIPS, THEREFORE, ARE NOT ONLY LIKELY TO BE LETHAL AT CLOSE RANGE, BUT ARE LIKELY TO BE INACCURATE AND INDISCRIMINATE AT LONGER RANGES, EVEN THOSE RECOMMENDED BY MANUFACTURERS FOR SAFETY.”

EGYPT: THE CASE OF SHAIMAA' EL-SABBAGH, KILLED BY BIRDSHOT

On January 24, 2015, Shaimaa' El-Sabbagh, a 31-year-old activist and member of the Egyptian Popular Socialist Alliance party, was killed in a public assembly that was forcibly dispersed by police using crowd-control weapons.²⁰ El-Sabbagh was shot with a 12-gauge shotgun, a weapon commonly used by the Egyptian police, particularly in responding to protests. She died from internal bleeding in the lung caused by birdshot injuries sustained to the chest, back, and face.

The protest was planned by the Popular Socialist Alliance Party to commemorate the 2011 revolution, and was attended by fewer than 50 people. The organisers had originally planned a march to Tahrir Square to place flowers and a wreath on the government-constructed memorial to the martyrs of the revolution. Shortly after the march started at midday, the Egyptian riot police – the Central Security Forces (CSF) – blocked the road. The party leaders tried to negotiate with senior police officers to allow the march to proceed, but the commanders refused and became visibly aggressive, threatening to forcibly disperse a protest that was not significantly blocking any traffic or causing any disturbance. Even though the party leaders started moving backwards, the riot police began sounding their sirens and firing tear gas and shotgun pellets in a manner that lacked any kind of gradualness or proportionality. Protesters and other bystanders began dispersing, while El-Sabbagh and a few others retreated in a slower fashion. In a video that documented the incident, a masked police officer is seen aiming and firing at this very small group of individuals who lagged behind. El Sabbagh

was struck by birdshot pellets from very close range – estimated by the Egyptian Forensic Authority to have been about eight metres.

Although the Egyptian police typically use small birdshot rounds – in this case 2mm pellet cartridges, which are supposed to be less penetrative – they still have very high lethal potential when fired from a short distance. Many countries prohibit the use of metal shot as excessively dangerous but several countries, including Egypt and Bahrain, use it regularly.²¹ The police officer seemed to have deliberately targeted El-Sabbagh, who was seriously injured and died shortly afterwards. Her colleagues who tried to assist her as she was losing consciousness were promptly arrested by the police. Because of the notoriety of the incident, spurred by the video of El-Sabbagh as she fell on the street, one police officer was prosecuted – a rare case of accountability for policemen in Egypt – and charged with “battery that led to death.” He was sentenced to 15 years in prison in June 2015, although the sentence has since been appealed.

Top: Socialist Popular Alliance Party activist Shaimaa al-Sabbagh (front R) is seen alive just before the shot hit her and killed her near the Tahrir Square during the protests held as part of the fourth anniversary of Egypt's January 25 revolution in Cairo, Egypt on January 24, 2015.

Bottom: A man carries Socialist Popular Alliance Party activist Shaimaa al-Sabbagh after she was shot near the Tahrir Square during the protests held as part of the fourth anniversary of Egypt's January 25 revolution in Cairo, Egypt on January 24, 2015.



Figure 2: Severity of Injuries Caused by KIPs

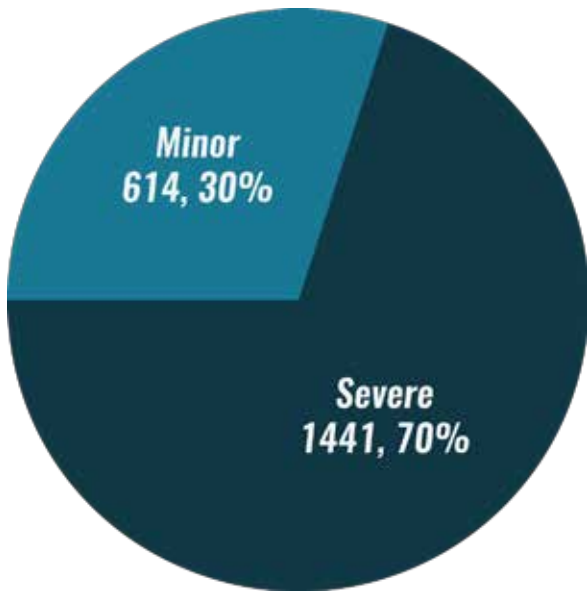

HEALTH EFFECTS

The health impacts of KIPs depend on a number of factors, including: the type of projectile; the weapon it is shot from; the distance from which the shot is fired; the user’s skill; and the inherent inaccuracy of the weapon itself. Although KIPs are designed to minimise penetrating injuries and limit the force of blunt trauma, both types of injuries are possible.

The findings of a systematic review of medical literatureⁱ indicate that KIPs cause serious injury, disability, and death. In the 26 studies selected for analysisⁱ, we identified 1,925 people with injuries, 53 of whom died as a result of their injuries (3 percent), and 294 individuals who suffered permanent disabilities (15 percent), the vast majority of which consisted of permanent vision loss (84 percent of eye injuries resulted in permanent blindness, usually requiring complete removal of the eye). Of those injured, 70 percent had injuries that were considered severe.^k Permanent disability and severe injuries often resulted from strikes to the head and neck (49 percent of deaths and 84 percent of permanent disabilities). Those with injuries to the torso were also at risk of severe injury. Specifically, one of every five people with abdominal injuries suffered a permanent disability. In addition, firing

distance and timely access to medical care were correlated with injury severity and risk of disability. While these findings do not enable estimates of the prevalence of morbidity and mortality associated with KIPs, they indicate that KIPs have resulted in significant morbidity and mortality despite their status as “less lethal weapons.”¹

Just under a quarter of the deaths (23 percent) resulted from blunt injury to the brain, spine, or chest. Many body systems can be injured as a result of KIPs, and both bullet penetration and blunt injury may result in severe acute injuries requiring surgery or medical care as well as chronic disabilities. Significantly, most of the severe injuries and permanent disabilities were from bullets that had a metal core or were otherwise composed of metal (discussed in more detail below).

According to the review, several factors affected the severity of the injuries that resulted from people being hit with a KIP, including firing distance, timely access to health care, and the composition of the bullet being fired.

Figure 3: People Injured by Rubber-Coated Metal Bullets vs Other Types of KIPs

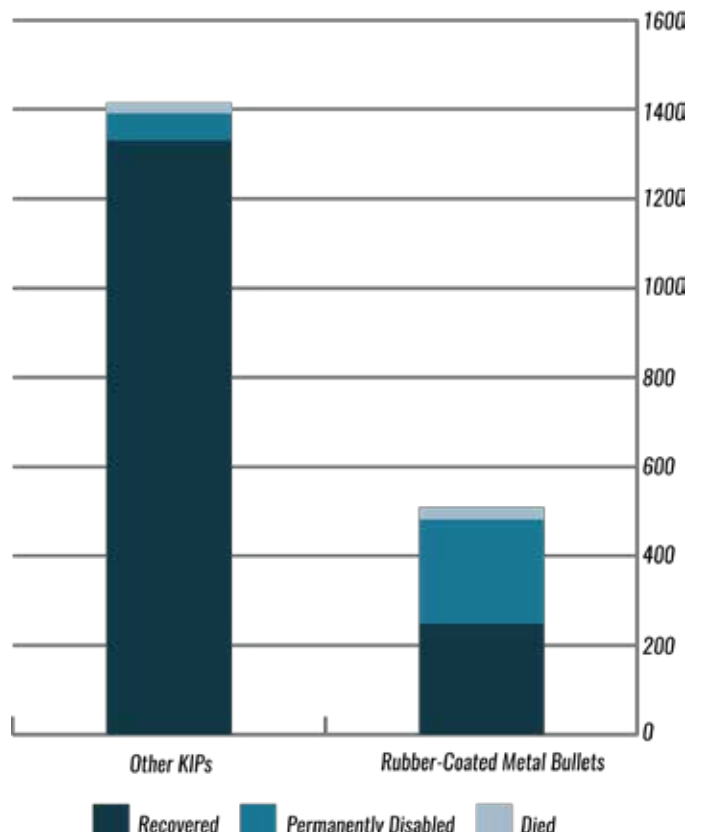

A. FIRING DISTANCE: The medical literature documenting injuries from KIPs suggests that deployment of these projectiles often occurs from distances much closer than those deemed safe. Safe shooting ranges are not well validated and vary a great deal between weapons, countries, and manufacturers. Firing distance, while hard to assess in many cases, correlates with the severity of injuries.^m One study suggested that penetrating injuries in parts of the body with high elasticity or viscosity indicated very close firing ranges in 42 patients.²² In another study, the injuries documented resulted from firing distances of 2.4 – 3 metres, markedly less than the typical recommended safe firing ranges of 9 – 14 metres.²³ Another study noted that more than half of the cases studied involved firing ranges of less than six metres.²⁴ Some of the literature specifically noted that firing distances in instances resulting in injury were less than those recommended by KIP manufacturers, and it highlighted that the firing distance was difficult to assess not only forensically, but also by law enforcement agents working in dynamic and fast-changing conditions.²⁵ Further, one study pointed out that KIPs can be extremely dangerous to eyes even when deployed at theoretically safe distances.²⁶

Different KIPs have different firing ranges and safety protocols. Depending on the discharging weapon and the bullet, these weapons should be fired from at least 6 to 60 metres away; however, they may lose their effectiveness or accuracy if fired from too great a distance. To provide but one troubling example, regulations identified in Israel actually indicate that minimum firing distance should be 50 metres for the rubber-coated metal bullet, but that after 60 metres the projectiles are ineffective, allowing for only a 10-metre range of acceptable use.²⁷

Other regions use a wide variety of launchers and bullets, each of which has its own specific safety and effectiveness ranges. Such conflicting and complicated guidelines can exacerbate the potential for misuse.

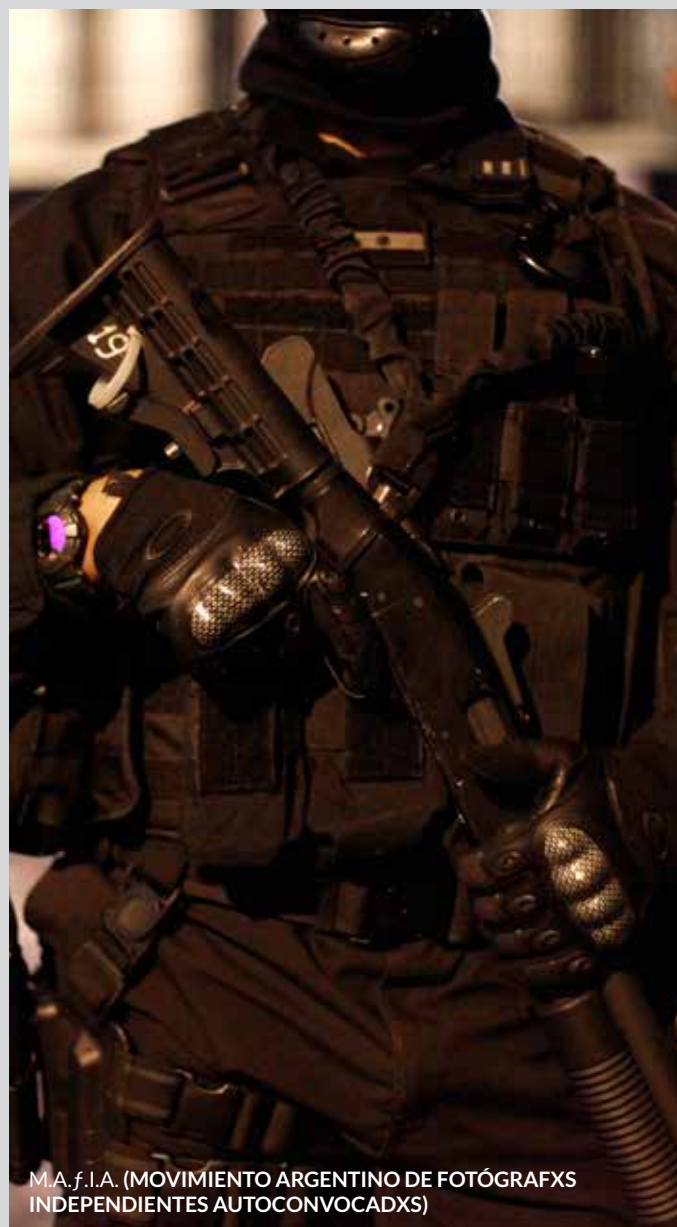

M.A.f.I.A. (MOVIMIENTO ARGENTINO DE FOTÓGRAFOS INDEPENDIENTES AUTOCONVOCADOS)

A police officer wearing riot gear walks in the centre of Buenos Aires, Argentina, during a protest on March 12, 2013.

ⁱ The review looked at literature over the past 25 years. The researchers identified 2,666 articles in a rigorous search of the medical and public health literature, out of which 24 articles met inclusion criteria, had clear causation by KIPs, contained health impact data, and were of sufficient quality to include.

^j Nine of the articles focused on protests, two on criminal arrests, and one on a riot (some of the articles presented information on more than one context). The remaining 14 articles did not specifically describe the context of use or had documentation of injuries from individuals in a variety of contexts.

^k Out of 1,878 people referenced in the study who survived KIP injuries, there were 2,055 injuries. In some cases, individuals sustained more than one injury, either because of multiple bullets or because they suffered contiguous organ injuries from a single bullet.

^l Morbidity is the state or incidence of illness or disease, while mortality is the state or incidence of death.

^m The firing distance of the weapon was specifically noted in seven of the articles as less than designated, or as directly related to the severity of injury. Exact distance was impossible to assess in most cases, but forensics and case data suggested that the firing distances were less than those recommended by manufacturers.

SOUTH AFRICA: THE DEATH OF ANDRIES TATANE

On April 13, 2011, the community of Ficksburg – a rural town in Free State, South Africa – embarked on a planned peaceful protest to voice its frustration regarding the lack of service delivery from their local municipality. Andries Tatane, a 33-year-old community activist, took part in the protest alongside thousands of other community members.

During the course of the protest, members of the South African Police Service (SAPS) attempted to disperse the protesters by firing rubber bullets and using water cannons. Tatane intervened in the SAPS's dispersal operation by standing in front of a water cannon truck, and was subsequently surrounded by members of the SAPS, who beat him repeatedly with police batons and tore open his T-shirt. Witnesses later stated that Tatane, who was unarmed, tried to stop the water cannon because elderly and vulnerable people were involved in the protest action.

While trying to defend himself, Tatane was shot twice in the chest from a range of approximately 1.5 metres with rubber bullets contained in a standard 12-bore shotgun cartridge. The cartridges were discharged by a member of the SAPS from what is thought to have been a Musler 12-gauge shotgun. Tatane was permitted to walk a short distance away from the scene of the shooting, and he collapsed with visible rubber bullet wounds to his chest. He died on the scene 20 minutes later, before he could be taken to a local hospital.

As a result of Tatane's death, eight police officers were charged in a local magistrate's court. All were acquitted. A subsequent inquiry by the South African Human Rights Commission, a constitutionally mandated institution tasked with investigating and reporting on the observation of human rights, found, among other things, that the members of the SAPS failed to comply with the provisions of the Regulations of Gatherings Act by using excessive force, which resulted in the injury and/or death of Tatane. It also found that the police used a degree of force that was disproportionate to the circumstances of the case.



Right: Andries Tatane stands after he was beaten and shot by the police with rubber bullets on April 13, 2011 in Ficksburg, South Africa.



“THE MEDICAL LITERATURE DOCUMENTING INJURIES FROM KIPS SUGGESTS THAT DEPLOYMENT OF THESE PROJECTILES OFTEN OCCURS FROM DISTANCES MUCH CLOSER THAN THOSE DEEMED SAFE. SAFE SHOOTING RANGES ARE NOT WELL VALIDATED AND VARY A GREAT DEAL BETWEEN WEAPONS, COUNTRIES, AND MANUFACTURERS.”

B. SITE OF IMPACT: While KIPs are touted as causing minor blunt injuries, the medical literature identifies many severe and often penetrative injuries requiring professional medical care and management. The location where the projectile hits the body is directly related to the severity of the injury. Despite guidelines calling for weapons to be aimed at lower extremities, the medical literature identifies many major injuries throughout the body, including to the head and trunk.¹¹ Injuries above the legs have the capacity to cause severe internal injuries, including ruptured solid organs, penetration to the abdomen or thorax, heart and lung injuries, injuries to the major vessels and nerves, and lethal head and neck injuries.

C. DELAYED ACCESS TO MEDICAL CARE: Delays in access to medical care can contribute to the risk of permanent damage as a result of KIPs as well.¹² Delays may be caused by medical personnel not immediately recognising the severity of injuries, overburdened hospitals, checkpoints, military curfews, and fear of arrest

Figure 4: Severity of Injuries Caused by KIPs by Body System

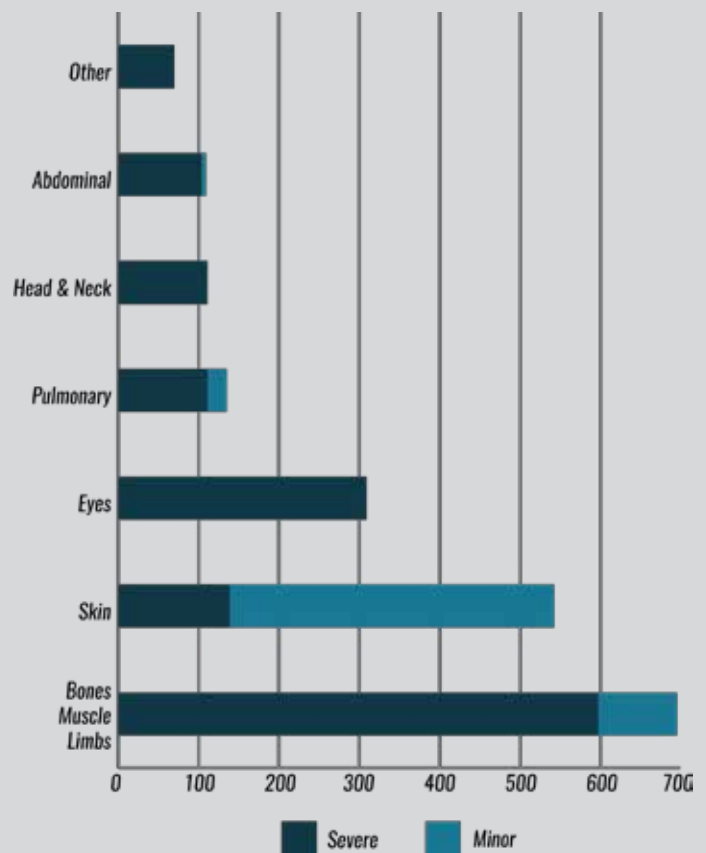

¹¹ Of the 2,055 injuries studied, only 33 percent were in the lower extremities. Injuries in other parts of the body include common contusions, bone fractures, internal bleeding, penetration of the projectile into vital organs, severe brain and eye trauma, and death.

¹² Several articles noted that delays to medical care from not recognising the severity of the injuries, and overburdened hospitals, as well as checkpoints, military curfews and fear of arrest or reprisals contributed to morbidity. Balouris notes that of 35 patients attending a speciality hospital directly, “only 9 were seen within 24 hours of injury.”

or reprisals associated with participating in a protest. This is significant, as one study noted that frequent curfews and evacuation times worsen the salvage rate from eye injuries,²⁸ and another found early management of vascular injuries allowed limbs to be salvaged, while late presentation with greater than six hours of delay had an 86 percent salvage rate.²⁹

D. BULLET'S COMPOSITION: There is evidence that specific bullets may be more dangerous than others. The literature identified a large proportion of severe injuries secondary to rubber-coated metal bullets and those with composites of metal and plastic, suggesting that they may be more lethal than bullets composed of plastic alone. Heterogeneity in the current literature, however, limits the ability to statistically compare different types of bullets. While there is some evidence that newer “attenuated energy projectiles” (with a soft sponge tip or a hollow plastic tip that collapses on impact) may mitigate some injuries from ricochet or deep penetrative injury, these and other KIPs are more prone to instability and unpredictable trajectories. Defective or poorly produced beanbag rounds have also been shown to cause severe or fatal injuries when they fail to expand during flight or when the bag ruptures upon impact.

The figures highlighted above show that while KIPs are sometimes described as “less lethal” than conventional ammunition, the number of deaths, serious injuries, and permanent disabilities that they can cause in a crowd-control setting is of serious concern. At close distances, some types of KIPs have the same ability to penetrate the skin as conventional live ammunition and can be just as lethal. When fired or launched from afar, these weapons are inaccurate, which raises the possibility of striking vulnerable body parts or causing unintended injuries to bystanders. These factors call into question the appropriateness of these projectiles for crowd-control purposes. (For specific recommendations on KIPs, see page 89).

ISRAEL: THE PROHIBITION OF RUBBER-COATED BULLETS

The proven lethal nature of rubber-coated metal bullets led the Israeli authorities to prohibit their use within Israel as a crowd-control weapon, except in extreme circumstances with special approval by the chief of police. This decision was made a decade ago following the recommendation of a commission of inquiry, known as the “Or Commission,” that was established by the government after 12 Palestinian citizens of Israel were killed and hundreds more injured during clashes between security forces and Palestinian citizens of Israel in October 2000. The commission report, released in 2003, criticised the Israeli police for being unprepared for the riots and for using excessive force to disperse the protesters. The commission concluded that rubber-coated bullets are lethal weapons and recommended they be prohibited as a means to disperse demonstrations. Unfortunately, these recommendations have not been applied in the Occupied Palestinian Territory, where the bullets are widely used and have caused dozens of deaths and many injuries, to both protesters and bystanders, since 2000.

ARGENTINA: POLICE USE OF RUBBER BULLETS AT THE BORDA HOSPITAL

On April 25, 2013, the Metropolitan Police of the city of Buenos Aires fired rubber bullets at patients, nurses, doctors, and journalists at the Borda Psychiatric Hospital. That morning, the city's Minister of Urban Development had ordered the demolition of one of the hospital's facilities, despite a court order that had suspended any type of eviction or demolition on the premises. The minister had requested a police deployment to guard the demolition process. Several hospital workers went out to take a stand against the demolition, and this incited a violent response by the Metropolitan Police, who attempted to disperse the protesters with batons, rubber bullets, and pepper spray. Several people were injured as a result of firing rubber bullets at close range. Footage shows the police firing from an estimated distance of 10 to 15 metres and at 90-degree angles.

Once word of the incidents got out, a number of members of the city legislature went to the site to initiate negotiations, at which point the police retreated. However, late in the day the protesters attempted to tear down the fence surrounding the workshop area upon learning that the demolition had already started. The remaining police forces reacted by "opening fire indiscriminately, at short range and aiming at the body."⁹ This second instance of use of force resulted in injuries to more than 40 people, including journalists, legislators, hospital workers, and patients. The injuries were caused mostly by rubber bullets and included lesions to the chest and arms, among others. One person sustained 21 impacts from rubber bullets on his body. Other people required medical attention because of the effects of tear gas.

The city government never notified hospital authorities that the demolition was going to take place, so that they could have taken the necessary preventive measures. The officers present were armed and wearing protective gear suited for an operation that might pose a potential risk to the forces; 12/70-caliber rifles were used to fire anti-riot munitions and tear gas cartridges. Some people were shot in the

face and the back, and, in some cases, with two different types of weapons.

The city government and the Metropolitan Police Chief jointly defended their actions at the Borda Hospital, pointing out that police officers "defended themselves" and that the operation was carried out according to the protocol for these cases.³⁰ This is despite the fact that the Metropolitan Police did not have at that time a protocol in place for handling protest and social conflict of that nature. The investigation of the Borda events was inadequate. The only officer prosecuted for causing "mild injuries" was the commissioner in charge of the special operations brigade that acted on the hospital premises. At the same time, the case against seven protesters accused of "resisting authorities" has already been taken to trial.

Police actions at Borda Hospital should not be considered an isolated event. In the last years, federal and provincial police forces have used rubber bullets in an indiscriminate way with the aim of dispersing manifestations across the country. In October 2014, National Gendarmeria shot at the workers of the company LEAR, who were protesting for the dismissal of some of them. At least 10 people required medical attention, one person counted 10 bullet impacts on his arm. In September 2015, Tucumán Police Force shot again at unarmed protestors who were trying to run away from the repression in Plaza Independencia. In December 2015 and January 2016, two more of these events happened in the first days of the new national administration in Argentina. The workers of bankrupt company Cresta Roja suffered the widespread use of rubber bullets again by Gendarmería to disperse their protest. A few days later, similar actions were taken by the Buenos Aires Police Force against civil servants in La Plata, where a woman was hit by nine bullets in her back. These cases show that the use of rubber bullets to disperse protests is widely used in Argentina, usually without previous warning, even towards unarmed people who are running away from the violence.



M.A.f.I.A. (MOVIMIENTO ARGENTINO DE FOTÓGRAFXS INDEPENDIENTES AUTOCONVOCADXS)



M.A.f.I.A. (MOVIMIENTO ARGENTINO DE FOTÓGRAFXS INDEPENDIENTES AUTOCONVOCADXS)

Top: Metropolitana Police push back people trying to prevent the demolition of a work space inside the Borda Mental Hospital in Buenos Aires, Argentina, April 26, 2013.

Bottom: A person present at the Borda Mental Hospital in Buenos Aires, Argentina, shows the casings of bullets used against protesters inside the premises on April 26, 2013.

3.2

CHEMICAL IRRITANTS

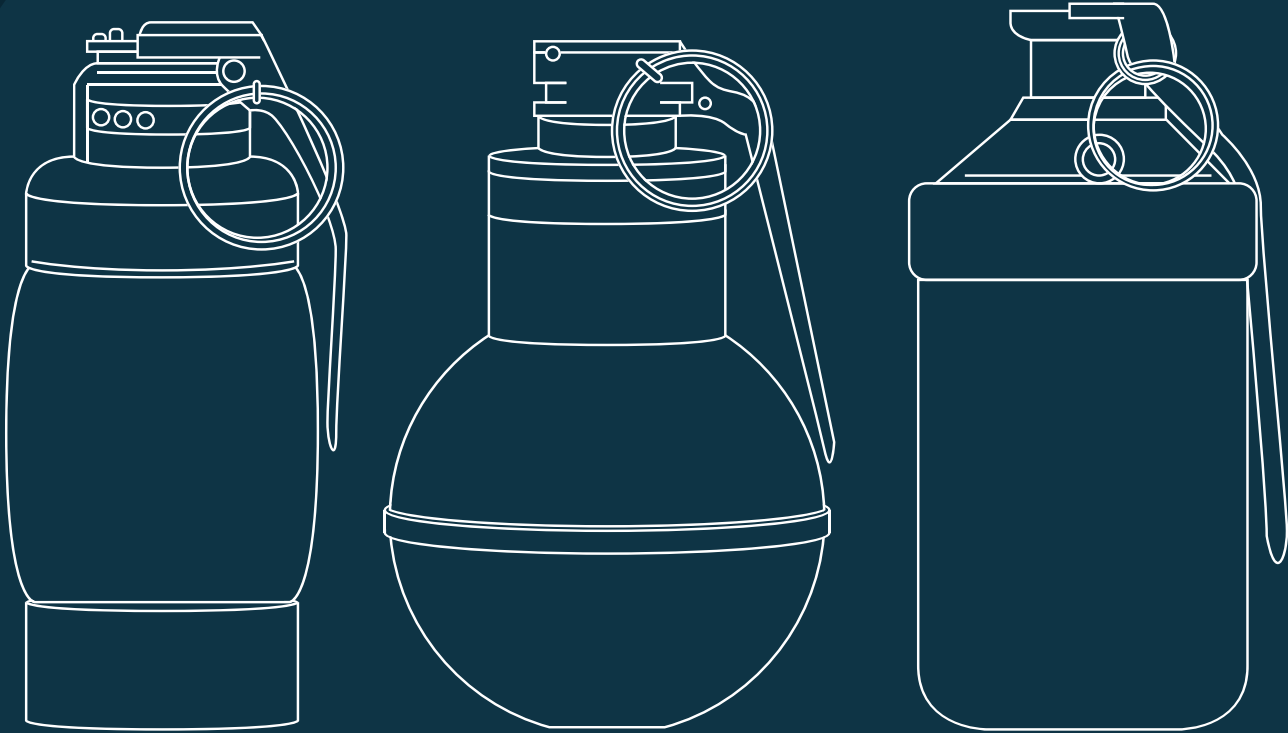

ILLUSTRATION BY KALE VANDENBROEK

WEAPON PROFILE

Chemical irritants are a group of CCWs that include a variety of chemical compounds intended to produce sensory irritation. Conventionally referred to as “tear gas,” chemical irritants come in a variety of formulations, sizes, concentrations, and delivery mechanisms, depending on the manufacturer and the context for which they are intended. Historically categorised as non-lethal or less lethal, the general perception is that the weapon does not cause permanent injury or death, but instead has mostly short-term effects such as transient lacrimation (flowing of tears), ocular irritation and pain, blepharospasm (eyelid spasm), dermal pain, respiratory distress, and the psychological effect of disorientation and agitation.⁹ This

perception is now being challenged, with more evidence of associated moderate and permanent injuries.

Chemical irritants include a wide range of agents that have been developed and deployed for many decades in addition to ones that are currently under development, but there are four chemical compounds that are most frequently cited in reports: chlorobenzalmalonitrile (agent CS), chloroacetophenone (agent CN), oleoresin capsicum (agent OC, known as pepper spray), and OC’s synthetic form, PAVA. Of these four, the two most commonly used by law enforcement agencies in recent years are agents CS and OC.

⁹ M. M. Stark, “CS Spray,” *Journal of Accident & Emergency Medicine* 15, no. 4 (July 1998): 288.

CHEMICAL IRRITANTS ARE AN INDISCRIMINATE WEAPON BY DESIGN; BECAUSE OF THEIR INDISCRIMINATE NATURE – ESPECIALLY WHEN DELIVERED BY FIRING A GRENADE OR A CANISTER – LIMITING THE EXPOSURE TO INDIVIDUALS OR SMALL GROUPS IS DIFFICULT, AND THE RISK OF AFFECTING BYSTANDERS AND INDIVIDUALS OTHER THAN THE INTENDED TARGETS IS HIGH.

Agent CS was developed in the 1920s in the United States, and was introduced as a weapon by the U.S. military to replace CN in the 1950s.^r It then became a frequently used weapon in the second half of the twentieth century and was famously deployed in the Vietnam War by the U.S. military.^s Now it is widely used by law enforcement agencies in many countries – often as the first weapon of choice in the context of protest. The United States used to be the main manufacturer of CS, but recently other countries have been producing and exporting the weapon. Despite the United States remaining the biggest producer of CS, the U.S. Environmental Protection Agency (EPA) has not set a minimum threshold of concentration at which the general population could experience “notable discomfort, irritation, or certain asymptomatic, non-sensory but transient effects,”³¹ because even the lowest concentrations cause these symptoms. The volume of chemical in each spray and gas varies considerably among manufacturers and countries.³²

Agent OC, the second most-commonly cited agent, is essentially a highly concentrated form of hot pepper. Agent OC and its synthetic form,

PAVA, have recently increased in popularity as potent and effective crowd-control agents. Also developed by the United States and originally used as a deterrent against wild animals (and by the U.S. Postal Service against dogs), OC became a law enforcement weapon in the late 1980s.³³ It is now available both as a spray and in gas form, with lower concentrations being available as a self-defence “pepper spray” for the public, while variants that are more potent are developed for military and law enforcement agencies. These more potent variants are also increasingly becoming a weapon of choice for crowd control. The potency of the weapon is not just contingent on the concentration of OC within the solvent, but particularly on the strength of the “capsicum” – the active chemical that makes pepper hot. It is worth noting that OC may also potentially include toxic chemicals, such as alcohol, halogenated hydrocarbons, and propellants such as Freon. While several countries have limitations^t on the possession and use of OC, in either spray or gas form, it is unregulated in most countries.³⁴

Right: Police use smoke bombs to disperse protestors at a rally outside the temporary G20 police detention center, where over 500 people were being detained on June 27, 2010 in Toronto, Ontario, Canada.

^r Ben B. Corson and Roger W. Stoughton, “Reactions of Alpha, Beta-Unsaturated Dinitriles,” *Journal of the American Chemical Society* 50, no. 10 (October 1, 1928): 2825–37, doi:10.1021/ja01397a037; Martha Lenhart, ed., *Medical Aspects of Chemical Warfare* (Office of the Surgeon General, Department of the Army, United States of America, 2008), chap. 13, <http://www.cs.amedd.army.mil/borden/Portlet.aspx?id=d3d11f5a-f2ef-4b4e-b75b-6ba4b64e4fb2>

^s E. J. Olajos and H. Salem, “Riot Control Agents: Pharmacology, Toxicology, Biochemistry and Chemistry,” *Journal of Applied Toxicology: JAT* 21, no. 5 (October 2001): 355–91.

^t Limitations vary by country. Some countries have limitations on use by law enforcement, especially regarding concentration, amount of volume carried, etc. Many other countries have limitations on possession/use by the general population.

MECHANISM OF ACTION

Chemical irritants are utilised for crowd dispersal or for individual control or incapacitation. They are typically deployed in two ways: in the form of spray or as a canister/grenade. However, mechanisms of delivery vary: these include pellets and pepper balls, used in targeting individuals, as well as water cannons, which, along with grenades and canisters, provide more indiscriminate means of crowd control. Newer forms include plastic balls filled with chemical irritants that act as a combination of plastic bullet and gas weapon.

The spray variant for CS, OS, and other gases is usually available in the form of an enclosed unit under pressure and is released as a fine spray by means of a propellant gas. These aerosolised forms of chemical irritants typically are released from 0.3 to 3 metres from the target, and the spray pattern can be variable depending on the design of the weapon, pressure of the spray mechanism, and wind conditions. Gas forms of chemical irritants are contained in canisters or grenades and typically are triggered to conduct a thermal explosion and disperse widely in the surrounding area.



Chemical irritants are an indiscriminate weapon by design; because of their indiscriminate nature –especially when delivered by firing a grenade or a canister – limiting the exposure to individuals or small groups is difficult, and the risk of affecting bystanders and individuals other than the intended targets is high. In addition, the diagnosis and treatment of chemical irritant exposure is complicated because of the combination of different chemicals and the lack of transparency about the agents used.

Agent CS, the most commonly used chemical irritant, is not actually a gas but rather a powder at room temperature that is aerosolised by a triggered thermal explosion and disperses widely from a canister. A gas canister is estimated to have between 80 and 120 grams of CS, usually in concentrations between 0.1 and 10 percent, but much higher concentrations are also commercially available.³⁵ The concentration of CS, however, can be significantly increased by the firing of multiple canisters in the same location, which is often the case in crowd-control situations and which further complicates analysis of the toxicity of the chemical in practice.

Several newer agents of CS are currently being developed, including agent CS1 and CS2.³⁶ Those new developments are expected to reduce degradation and extend the shelf life of CS or, in the case of CS2 in particular, to increase weather

resistance and flow into the respiratory system by microencapsulating the CS in silicone.

In order to understand accurately the effect of exposure to CS, a measurement of density or concentration (milligrams per cubic metre) for exposure time is necessary. Based on animal and human models, it is estimated that an exposure to agent CS at a concentration of 140 mg/m³ for 10 minutes or 11 mg/m³ for one hour, or as little as 1.5mg/m³ for four to eight hours can be lethal.³⁷ Individuals exposed to high concentrations in closed spaces or for extended amounts of time, for instance, can suffer serious health consequences and even death. When used outside, a CS grenade or canister produces a cloud of chemicals, usually within 60 seconds, with the highest CS concentration of 2,000 to 5,000 mg/m³ detected at the centre of the cloud. Because of the nature of the weapon, it is difficult to measure these concentrations in practical situations of deployment or to have accurate estimates in retrospect.

Agent OC, most commonly found in spray form, is available in different concentrations from 1 to 10 percent of capsaicinoids as oil in a solvent. Studies suggest that even very low (0.003 mg/m³) concentrations can lead to ocular irritation.³⁸ Because of the complexities in measuring concentrations of agent OC, lethal dose levels are difficult to verify.

Left: Officers pepper spray people near West North Avenue and Pennsylvania Avenue during a protest for Freddie Gray in Baltimore, MD on Monday April 27, 2015.

Figure 5: Physical and Chemical Characteristics of Selected Chemical Irritants*

NAME	CHARACTERISTICS	TIME TO ACTIVATION (SECONDS)	DURATION OF ACTION (MINUTES)	LD50 (MG/MIN PER M3) - INCAPACITATING DOSE	LD50 (MG/MIN PER M3) - LETHAL DOSE
Agent CN	Apple odour; powder or emulsion; aerosol	3-10	10-20	20-50	8,500 - 25,000
Agent CS	Pepper odour; dispersing effect (grenades)	10-60	10-30	4-20	25,000 - 100,000 ^u
Agent OC	Pepper odour; persists for long periods	1-5	30-60	Unknown	Unknown

* Table adapted from Carron and Yerson, Management of the Effects of Exposure to Tear Gas, 2009.³⁹ The Median Incapacitating Dose (ID50) is the amount of agent expected to incapacitate 50 percent of a group of exposed, unprotected individuals. The Median Lethal Dose (LD50) is the amount of agent expected to kill 50 percent of a group of exposed, unprotected individuals.

^u In pharmacology, the margin of safety is the range between the usual effective dose and the dose that causes severe or life-threatening side effects. Agent CS has a lower effective dose and a higher toxicity dose than agent CN, resulting in a wider margin of safety.

Figure 6: Severity of Injuries Caused by Chemical Irritants

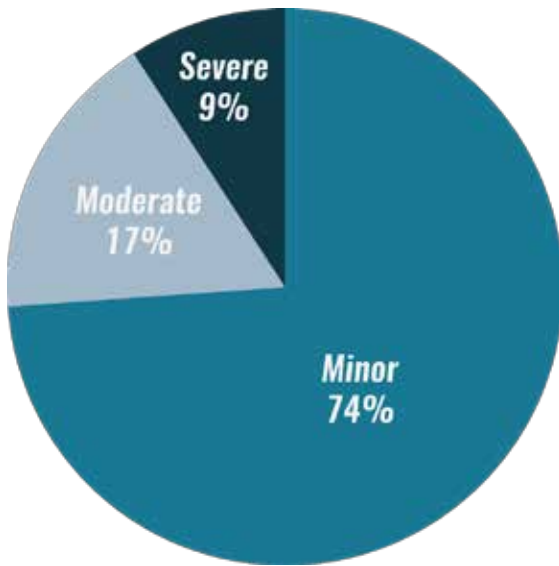

HEALTH EFFECTS

A systematic review of medical literature documenting the health impact of different chemical irritants was carried out for this report in order to identify documented cases of injuries, deaths, and permanent disability over the past 25 years. A total of 31 studies were included in the analysis.^v Further analysis of the frequency, context of injuries, and risk factors was undertaken.

The review identified 5,131 people who suffered injuries or died; of these, two people died and 70 people (1.7 percent) suffered permanent disabilities. The majority of people who were injured (5,059) fully recovered from their injuries (98.6 percent). Out of 9,261 documented injuries, (many people had multiple injuries), 8.7 percent were severe and required professional medical management, while 17 percent were moderate, and 74.2 percent were minor.

Severe injuries surveyed included injuries to multiple body systems, with the majority of injuries being to the skin, eyes, and cardiopulmonary system (lung, heart, and chest). Two deaths were documented in the literature review; one as a result of respiratory arrest after CS was fired inside a home and one from traumatic brain injury sustained

after the victim was directly hit by a canister. No cases of death associated with OC were found. Reviewed studies also included cases of 70 people with documented permanent disabilities, which included globe (eyeball) ruptures and blindness (four people), traumatic brain injury resulting in a vegetative state (one person), limb amputations (three people), and functional loss of limbs (ten people). Persistent psychiatric symptoms were found in 14 people and persistent symptoms of asthma and other respiratory conditions were reported in 32 people.

The study also found that the majority of people injured are young adults (mean age: 25.7 years), consistent with traditional protest demographics.⁴⁰ Though most reports indicate that young men are more likely to incite violence, our study notes a more equal gender distribution of injuries, which is consistent with the indiscriminate nature of chemical irritants (57 percent male, 43 percent female).⁴¹ Thirteen of the 31 studies reviewed for this report included injury data on children (some as young as three months old). Studies suggest that children are more vulnerable to severe injuries from chemical toxicity.⁴² The elderly and those with chronic diseases may also be more prone to worse outcomes from chemical irritants.⁴³ The studies reviewed documented injuries in people over 65, with some as old as 90 and 94. The data identified chronic respiratory conditions and allergic skin conditions in people who had previous medical conditions.

The psychological impact of the use of CCWs has not been well studied or documented in the medical literature, but cases documented in this review indicate that exposure to chemical irritants may result in significant psychological symptoms and long-term disability. In one study of 297 individuals seeking care and/or evaluations of injuries following the 2013 Gezi Park protests in Turkey, 117 psychiatric evaluations were conducted. Some 43 percent of the victims had diagnostic criteria for acute stress disorder, 23 percent had diagnostic criteria for post-traumatic stress disorder (PTSD), and 7.7 percent had diagnostic criteria for major depressive disorder.⁴⁴

“THE REVIEW IDENTIFIED 5,131 PEOPLE WHO SUFFERED INJURIES OR DIED; OF THESE, TWO PEOPLE DIED AND 70 PEOPLE (1.7 PERCENT) SUFFERED PERMANENT DISABILITIES. THE MAJORITY OF PEOPLE WHO WERE INJURED (5,059) FULLY RECOVERED FROM THEIR INJURIES (98.6 PERCENT).”

Figure 7: Severity of Injuries Caused by Chemical Irritants by Body System

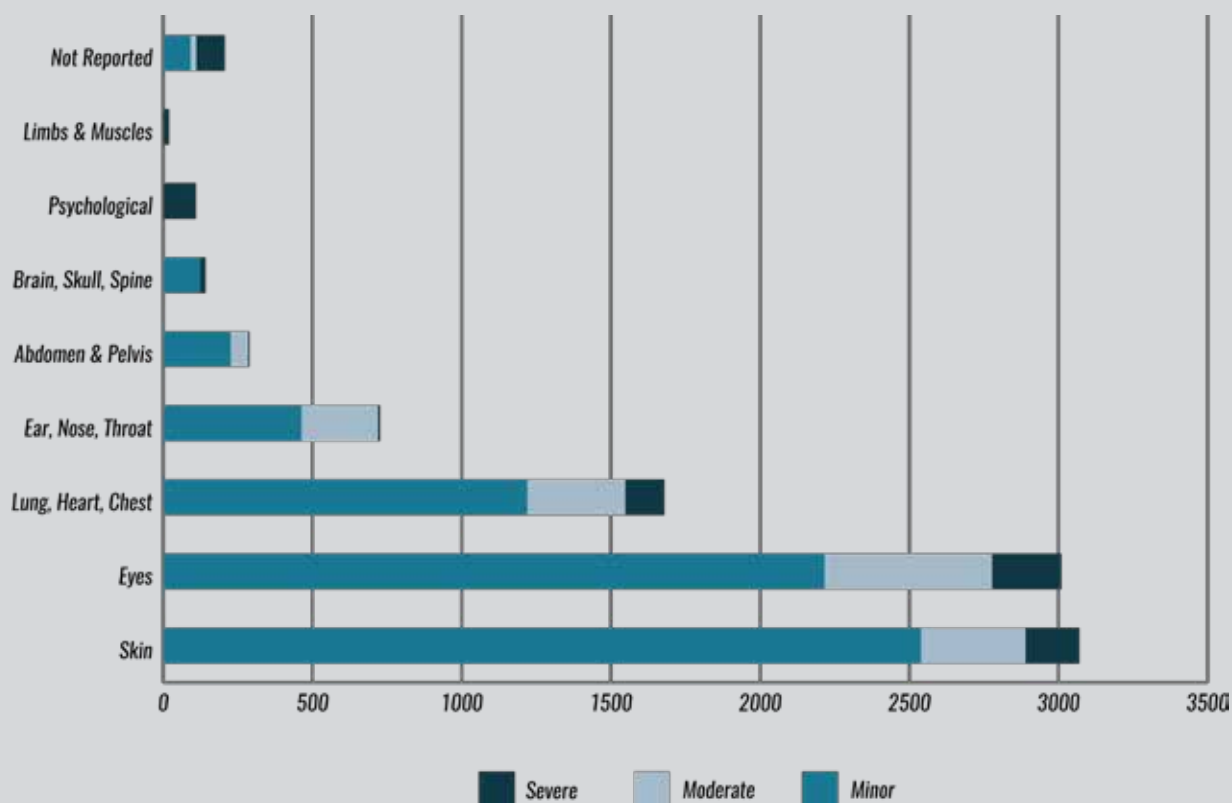

^vArticles were included in the review if they documented injuries, deaths, or other health consequences of chemical irritants on human subjects and were published between January 1, 1990 and March 30, 2015. The selected studies included data from 11 countries and were published between 1993 and 2000. The most common context of injuries surveyed was protests (10 studies), but the review also included injuries sustained in the context of arrests/police duty, military or police training exercises, accidental exposures, and a detention unit riot.

KENYA: #OCCUPYPLAYGROUND

EXCESSIVE FORCE IN THE QUELLING OF A PUBLIC DEMONSTRATION AT LANGATA ROAD PRIMARY SCHOOL

On January 19, 2015, the children of Langata Road Primary School, together with their parents and teachers, members of civil society, and legislators of the National Assembly and County Assembly of Nairobi gathered peacefully to protest the seizure of their playground by private developers. During the December school holidays, a private developer had erected a perimeter wall and gate around the playground and taken control of it. On this day, the children left their classes alongside other protesters and marched to their playground carrying placards and chanting “Haki Yetu!” (“It’s Our Right!”). At the playground, 108 police officers had been deployed in anticipation of the protest and were under the command of the officer in charge of Langata Police Division. The police were armed with AK-47s, G-3 rifles, tear gas canisters, and a dog unit. The police described their task as safeguarding life and property while also ensuring the safety of the school children.

Upon reaching the playground, the children and other demonstrators began to push on the erected gate to gain access to the playground. As the pressure on the gate escalated, it was opened by the police officers, who immediately fired tear gas canisters directly at the children and the other protesters. This action caused a stampede as the children, demonstrators, and other members of the public nearby scrambled for safety. Five children and one police officer were injured and taken to hospital. The injuries were related to tear gas exposure as well as the ensuing stampede. Most of the injuries were described as soft tissue injuries. While four children were treated and released from hospital, one child was admitted for chest pains and difficulty breathing. The police also arrested three activists, who were subsequently released on bail.

Having received widespread local and international media coverage, the incident was swiftly condemned by the public, who denounced the use of tear gas and dogs on children. The matter was eventually investigated by the Commission on Administrative Justice (the Office of the Ombudsman). The acting inspector general of police also announced the suspension of the commander as an immediate consequence of the incident. The officers directly responsible for lobbing the tear gas were not identified.

In its investigation of the case, the ombudsman found the county police commander and the officer in charge guilty of dereliction of duty for failing to inform the school administration of their assessment of the risks posed by the demonstration so that precautionary measures could be put in place. The investigation also found line commanders guilty of dereliction of duty for failing to control officers’ actions and for their “inability” to identify the officers who fired tear gas at the students. The ombudsman recommended a series of disciplinary measures for the guilty officers and a series of policy and standard operating procedures reforms, but none of these recommendations has been implemented to date.

Top: Schoolchildren from the Lang’ata road primary on January 19, 2015 in Nairobi protest after they broke a wall illegally erected around their playground, which was allegedly grabbed by a powerful politician.

Bottom: School children from the Lang’ata road primary school scramble up a bridge on January 19, 2015 in Nairobi to escape tear gas after police attempted to break up their demonstration against the removal of their school’s playground, which was allegedly grabbed by a powerful politician.



TONY KARUMBA/AFP/GETTY IMAGES



TONY KARUMBA/AFP/GETTY IMAGES

REVIEWED STUDIES ALSO INCLUDED CASES OF 70 PEOPLE WITH DOCUMENTED PERMANENT DISABILITIES, WHICH INCLUDED GLOBE (EYEBALL) RUPTURES AND BLINDNESS, TRAUMATIC BRAIN INJURY RESULTING IN A VEGETATIVE STATE, LIMB AMPUTATIONS, AND FUNCTIONAL LOSS OF LIMBS.

Moreover, the severity of injuries from chemical irritants was correlated with the kind of chemical agent used and the method of deployment.

A. TYPE OF CHEMICAL AGENT: Most of the injuries documented were caused by CS (26 of the studies reviewed) or OC (14 studies). In total, agent CS alone was identified in studies that included 607 minor injuries, 492 moderate injuries, and 326 severe injuries. Agent OC alone was documented to have caused 5,875 minor injuries, 848 moderate injuries, and 433 severe injuries. There was a much higher number of total documented injuries caused by agent OC (7,156 total injuries) as compared to agent CS (1,425 total injuries), but the proportion of documented severe injuries was higher for agent CS (22.8 percent) compared to agent OC (6 percent).

Data collected from reviewed literature suggested that agent CS can cause unexpected skin reactions, such as chemical burns and hypersensitivity reactions, as well as respiratory illness.

B. DEPLOYMENT MECHANISM: The selected studies documented injuries caused by both spray and gas forms of both chemicals. The review identified 5,366 minor injuries, 884 moderate injuries, and 483 severe injuries from spray forms of agent CS and OC (15 studies), whereas the gas forms were responsible for 1,512 minor injuries, 676 moderate injuries, and 281 severe injuries (12 studies). Some 7.2 percent of the injuries from spray forms of chemical irritants were severe and 11.6 percent of injuries from gas forms were severe. This shows that gas forms of chemical irritants (contained in canisters or grenades and released and widely dispersed by a thermal explosion) contributed to a marginally higher percentage of severe injuries. In addition, a number of the studies reviewed highlighted both distance/proximity to the area where the chemical was released and the force of the propellant as factors impacting the health effect on individuals. Therefore, comparative analysis of the deployment mechanisms using pooled data was not conducted, given the concern for confounding factors.

Figure 8: Injury Severity by Deployment Mechanism

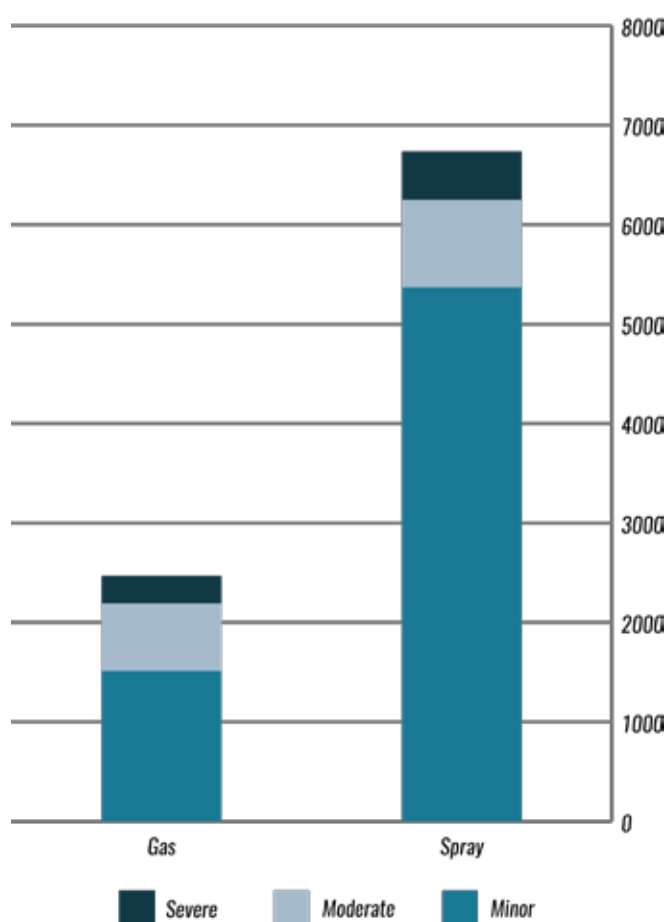

The use of canisters was documented to have caused 231 injuries, of which 63 (27 percent) were severe. There were 67 traumatic injuries to the head and neck, including at least 6 people who lost vision in an eye due to canister trauma. The studies reviewed documented 45 injuries to the torso (chest, abdomen, back, and genitalia). There were 61 upper extremity injuries and 34 lower extremity injuries (including at least 3 people requiring amputations and 16 with severe functional loss of a limb due to neurovascular injuries). A total of 18 dermal injuries (8 percent) included bruises, lacerations, and heat burns.

Many of the selected studies identified other factors that may potentiate injury, such as environmental conditions (heat, humidity, and wind conditions), prolonged exposure, and exposure in enclosed spaces. Several other factors were documented as exacerbating the potential for injury, but were lacking in detailed data, such as documentation of specific injuries for analysis. Utilising the weapons in confined spaces, and in areas where people

could not easily escape, potentially increased the exposure to the irritant either in quantity or over time. One study in a detention centre suggested that the excessive number of injuries may have been exacerbated by the crowded and enclosed setting that offered no opportunity for escape.⁴⁵ Use of chemical irritants in areas with high heat or humidity potentially exacerbated skin irritation, and windy conditions risked the contamination of law enforcement officers, bystanders, or nearby residences and businesses. One study highlighted that use of agent CS for military training on a particularly humid day, followed by strenuous exercise by trainees, may have caused severe respiratory injuries that resulted in several people requiring ICU-level care.⁴⁶ Direct targeting of the face and eyes by spray has been noted to cause trauma and toxicity to the cornea and conjunctiva of the eye.

The findings of this systematic review identify significant morbidity and two deaths associated

Figure 9: Severity of Injuries Caused by Canisters by Body System

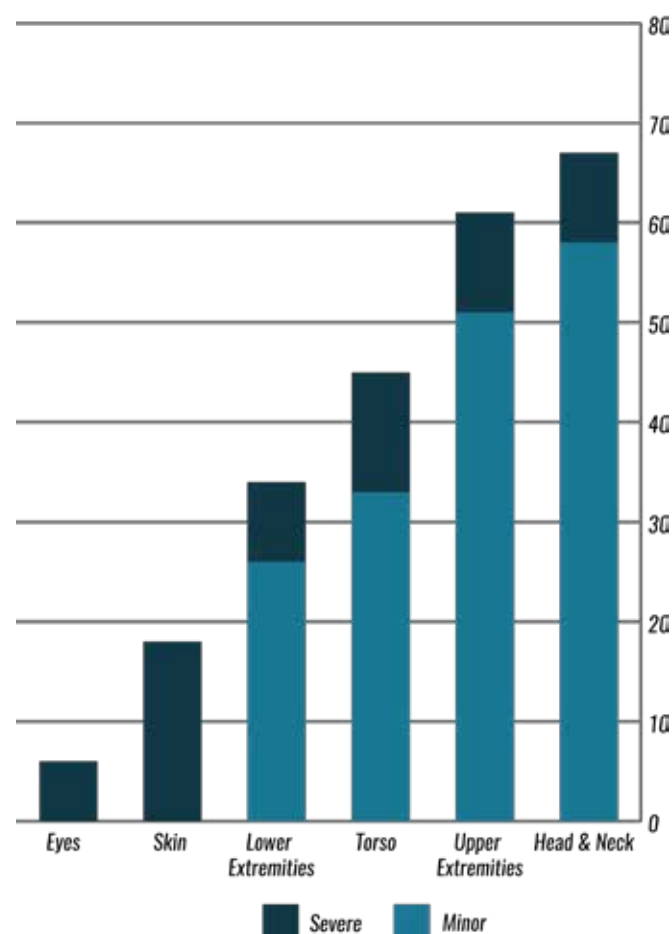

EGYPT: THE CASE OF THE ABU ZAABAL POLICE VAN

On August 18, 2013, 37 prisoners in pre-trial detention died in a police van parked at the entrance to the Abu Zaabal prison complex in Egypt after a canister containing the chemical irritant agent CS was thrown into the closed vehicle. They were among 45 prisoners who were being transported from a police station to the prison complex in the desert, northeast of Cairo.

In the months of August to October 2013, thousands of people were arrested and there was a sudden hike in incarceration rates in Egypt, causing overcrowding in detention facilities. Against this backdrop and in the sweltering heat of an Egyptian August, a poorly ventilated police van – already carrying more than its capacity – queued up in a long line of other police vehicles at the entrance to the Abu Zaabal prison complex. As is customary in the transportation of prisoners in Egypt, the 45 prisoners inside the van were cuffed to each other in couples. According to the first instance court case file,⁴⁷ the police van arrived at Abu Zaabal sometime after 7 a.m., and had to wait at the entrance to the inside prison for more than six hours while paperwork was being processed. The temperature outside soared above 30 degrees Celsius. The prisoners knocked on the walls of the van for air and water, and, once or twice, the accompanying guards opened the van's door and gave them water. But the chief in charge of the operation refused to let prisoners out or leave the door open. Sometime around noon, the banging on the doors increased, and, despite the lack of independent eyewitnesses, evidence in the case suggests that a police officer – who has not been identified – opened the door and fired a CS canister into the van. Survivors were merely aware of the fact that they had been gassed, and most of them started losing consciousness. It was only around 2 p.m. that guards opened the doors and realised that most of the prisoners had lost consciousness, and that ultimately 37 of the 45 individuals inside the van had died.

When imagery of the swollen, blackened bodies in the morgue emerged, the prosecution ordered an investigation,⁴⁸ and four police officers were tried in a misdemeanour court for manslaughter. The police officer who fired the canister was never identified, and the police claimed that if any gas was used, it could only have been CS spray used for self-defence. However, the Egyptian Forensic Authority ruled that the concentration of CS found in the bodies of the deceased could only have been caused by the firing of a canister or a grenade, and that the closed space of the van and the heat exacerbated the conditions and led to the deaths. In March 2014, a first instance court sentenced the chief of the operation to ten years in prison and three other officers to one-year suspended jail sentences. In June 2014, an appeals court reversed the conviction, but the prosecution appealed against that decision and a retrial was ordered. In August 2015, another misdemeanour court sentenced the chief of the operation to five years in prison and maintained the original verdicts for the other officers.



THE PREVAILING PREMISE FOR THE WIDESPREAD USE OF THESE CHEMICAL AGENTS IS THAT THEY CAUSE MINIMAL AND TRANSIENT IRRITATION TO THE SKIN AND EYES, BUT ARE GENERALLY SAFE FOR USE ON DIVERSE POPULATIONS. HOWEVER, THE REVIEW OF THESE STUDIES FOUND THAT, BY DESIGN OR BY INAPPROPRIATE USE, CHEMICAL IRRITANTS CAN CAUSE SIGNIFICANT INJURIES, PERMANENT DISABILITY, AND DEATH.



with chemical irritants agent CS and agent OC. The prevailing premise for the widespread use of these chemical agents is that they cause minimal and transient irritation to the skin and eyes, but are generally safe for use on diverse populations. However, the review of these studies found that, by design or by inappropriate use, chemical irritants can cause significant injuries, permanent disability, and death. These consequences may be related to the type of chemical agent used, levels of exposure, the deployment technique, and the way these weapons are used in different jurisdictions. Although the study excluded secondary injuries,^w it is worth noting that there were several cases in the review of chemical irritants causing mass panic and stampedes that contributed to significant morbidity and mortality, including 20 deaths in a football stadium in Egypt. These numbers were not included in the data analysis and above statistics.⁴⁹ Moreover, accidental exposure is common and sometimes difficult to avoid.

In addition to documenting injuries, the review identified other factors that may affect injury severity. Inherent qualities of the chemical agents may play some role in injuries. Chemical irritants, especially those deployed in gas forms, are inherently indiscriminate and can impact not only the intended targets

but also other demonstrators, bystanders, neighbourhood businesses and residences, and law enforcement officers themselves. This shows that accidental exposure is common and sometimes difficult to avoid. Because of the indiscriminate nature of chemical irritants, limiting the exposure to individuals or small groups is difficult, while exposing large and diverse groups to the weapons poses the risk of widespread injuries, including to potentially vulnerable people.

We also note that combinations of OC and CS are becoming more common, both in spray and gas forms as well as within projectiles such as the “pepper ball.”^x These forms, along with chemical agents dissolved in water cannons, have not been well studied and could cause other injuries.^y Perhaps even more concerning are the unknown effects of these chemical agents in chronic exposure settings in which safety has never been studied and cannot reasonably be assumed. This should be particularly concerning for law enforcement officers with repeated exposure, frequent protesters, and health workers who may sustain multiple occupational exposures. More research is needed in this regard. (For specific recommendations on chemical irritants, see page 89).

^w Secondary injuries, in this report, are defined as injuries caused by the use of a specific weapon but not directly attributable to it.

^x E. J. Olajos and H. Salem, “Riot Control Agents: Pharmacology, Toxicology, Biochemistry and Chemistry,” *Journal of Applied Toxicology*: JAT 21, no. 5 (October 2001): 355–91.

^y Tear Gas Devices, Code of Federal Regulations, vol. 173.340, 2001, <https://www.law.cornell.edu/cfr/text/49/173.340>

HUNGARY: POLICE ATTACK ON PROTESTING REFUGEES

In the face of the most serious migration crisis to hit Europe in decades, the Hungarian government took legal and physical steps to stop refugees at its southern border. The Serbian section of the country's border was sealed with barbed wire fences, while arguably unconstitutional criminal sanctions were introduced. The new border-control measures took effect on September 15, 2015. As a result, thousands of refugees were stopped at the Serbian side of the Röszke-Horgos border crossing point, where they were not provided with any relevant information, accommodation, or medical treatment, while they underwent a slow, official border-crossing procedure.

On the afternoon of September 16, 2015, behind a cordoned gate at the border crossing point, Hungarian riot police troops were arrayed after a group of refugees started to protest and tried to convince the police to open the gate and let them through. At 2:30 p.m. stones were thrown over the cordon; first line police officers responded by using pepper spray against the first line of refugees. This led to an escalation in the violence; the crowd became aggressive and started throwing stones again, as well as pieces of wood and plastic bottles. The police then fired tear gas and used water cannons against the refugees from the other side of the gate. Due to the indiscriminate effects of these weapons, peaceful refugees, children, and women were affected.⁵⁰

At 5:30 p.m. that day, the police removed the cordons and the troops were pulled back. Some refugees then opened the gate and hundreds of people – including women, children, and elderly people – started to cross the border yelling “Thank you!”, believing that the border had been officially opened. Though the crowd behaved peacefully, troops from the Hungarian Counterterrorism Centre (CTC) suddenly ran from behind the police lines and began attacking those walking through, beating them indiscriminately with truncheons and telescopic batons. The people turned back

and tried to run, but CTC officers hunted them down. During the attack, journalists with cameras were also beaten and hit with rocks, even those who lay on the ground or tried to help others. The injuries and unlawful treatment of journalists are well-documented.⁵¹ The media reported that around 300 refugees had been injured, while the police reported that about 20 policemen had been injured.⁵²

During the attack, the CTC officers were wearing protective gear but did not wear identification numbers, and there is no information, so far, on who ordered the attack. There is also no substantiation of police claims that the crowd had been warned three times, as required by law, before the attack began. The CTC refused to comment on the incident, and didn't publish any pictures taken – in spite of the fact that recordings of many other operations have been publicised. The internal investigation conducted by the head of the police concluded that all the actions were lawful, skillful, and proportionate. However, the police force conducted investigations against 14 people, and 10 people were prosecuted for rioting.

The Hungarian Helsinki Committee has asked the Commissioner for Fundamental Rights to initiate an investigation regarding fundamental rights violations in the incident, but the commissioner refused to do that, stating that he has no competence in this case. The Hungarian Civil Liberties Union tried to acquire the police incident reports through freedom of information requests, but these requests have only been partially answered and partially denied based on inadequate reasons. A proper investigation that could offer transparency and accountability by the police for these actions remains pending.

Top: Refugees cover themselves with a blanket as they run away from tear gas during a clash with Hungarian riot police at the Horgos border after Hungarian authorities closed their border in Horgos, Serbia on September 16, 2015.

Bottom: Refugees cover their faces as they run away from tear gas during a clash with Hungarian riot police at the Horgos border after Hungarian authorities closed their border in Horgos, Serbia on September 16, 2015.



ARPAD KURÚCZ/ANADOLU AGENCY/GETTY IMAGES



YOTAM RONEN/ACTIVE STILLS

3.3

WATER CANNONS

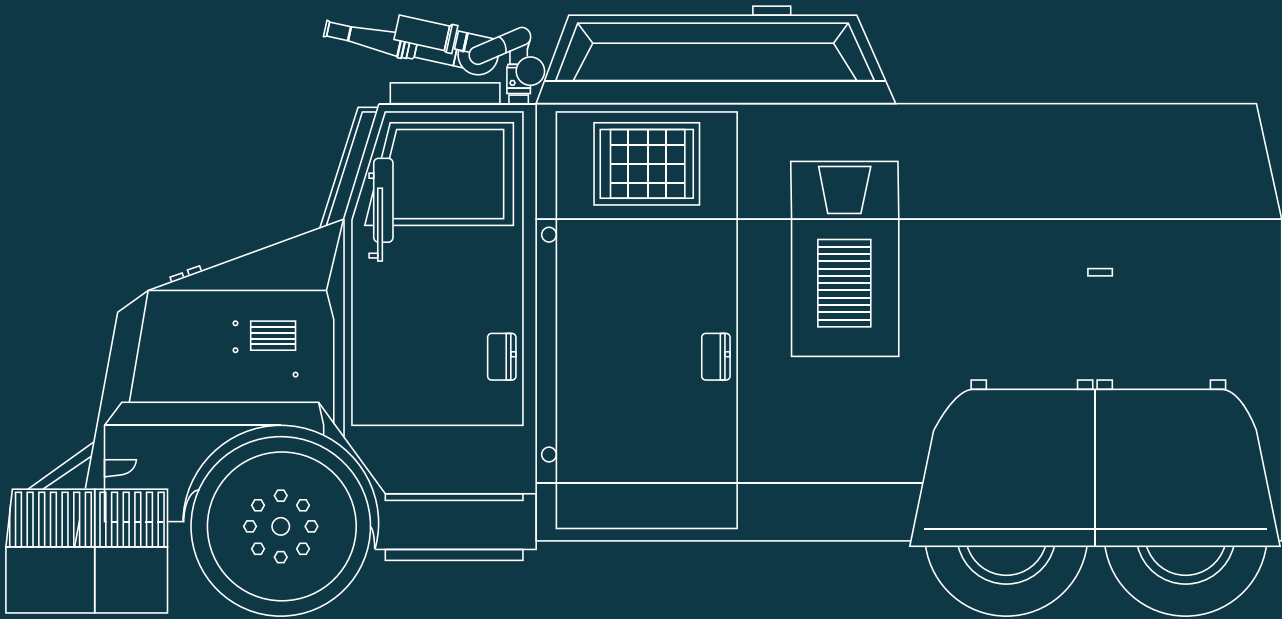
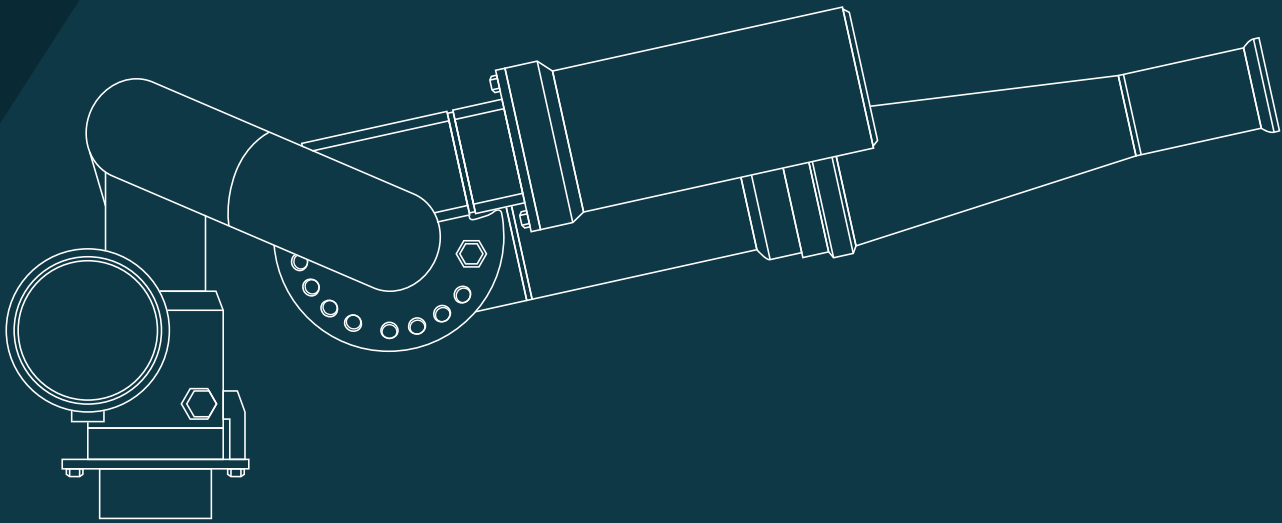

ILLUSTRATION BY KALE VANDENBROEK

WEAPON PROFILE

High- or low-velocity streams of water are commonly used as a crowd-control weapon. Typically referred to as water cannons, various types of water hoses either connected to in-ground water supplies or mobile bladders (often on trucks) have been used since the early 1700s, initially for fighting fires and later also for dispersing crowds or limiting access to certain areas.⁵³

Water cannons were first used for crowd control in the 1930s in Germany, and, by the 1960s, were in frequent use in the United States during civil rights protests.⁵⁴ Water cannons have been used as a crowd-control weapon in protests all over the world and continue to be used regularly, now most often as large truck-mounted devices.



MECHANISM OF ACTION

Water cannons function by propelling streams of water towards protesters. These can be either high-pressure streams, aimed at pushing back crowds, or low-pressure streams intended to douse. High-pressure water cannons can have flow rates (volume of fluid) of up to 20 litres of water per second, with an operating pressure of 15 bar (220 psi), and can stream water 67 metres away.⁵⁵ By comparison, a typical residential showerhead has a pressure of 3 bar (40 psi). High-pressure, high-volume water cannons can knock individuals down and push them backwards with significant force, particularly when this pressure is sustained and exerted over a wide surface area.⁵⁶

In addition to pressurised water, dye or other chemical agents may be mixed into water cannons to exert secondary impacts. Coloured dyes, often semi-permanent and requiring several days and numerous cleanings with strong detergents to remove, have been used for more than 25 years in many places, including India, Indonesia, Israel, Hungary, Northern Ireland, South Africa, South Korea, and Uganda.⁵⁷ In addition to publicly marking protesters, coloured dyes have also been used to humiliate protesters, particularly when marked with undesirable colours (such as bright pink, used in Uganda and Indonesia).

Some water cannons have also been used with ultraviolet dyes to assist where there is delayed identification and/or arrest of protesters.⁵⁸ Most modern water cannons can also be injected with a stream of chemical irritants such as agent CS or OC, and chemical irritant manufacturers produce powdered versions for this purpose.⁵⁹ Foul-smelling chemicals have also been used in water cannons in recent years, often coating not only individuals but also nearby homes and businesses in malodorous and difficult-to-remove chemicals of unknown toxicity.⁶⁰ There are no publicly available guidelines on the appropriate use of water cannons, including details on minimum distance, water pressure, and use-of-force protocols.



“FOUL-SMELLING CHEMICALS HAVE ALSO BEEN USED IN WATER CANNONS IN RECENT YEARS, OFTEN COATING NOT ONLY INDIVIDUALS BUT ALSO NEARBY HOMES AND BUSINESSES IN MALODOROUS AND DIFFICULT-TO-REMOVE CHEMICALS OF UNKNOWN TOXICITY.”

ISRAEL: THE SKUNK – A HUMILIATING WEAPON

The “Skunk” is an Israeli invention intended to disperse crowds. It consists of a water cannon that sprays large surface areas with an extremely foul-smelling liquid from a special vehicle. The liquid is made of water, yeast, and baking soda, and the foul smell it produces stays for days on any surface that it touches, such as asphalt, walls, clothes, etc. Spending time in a home that has been affected by Skunk, or even on a street where a large quantity of Skunk has been sprayed, is very difficult, even three to four days after the liquid has been used. The physical side effects of the Skunk may include nausea, skin rash, and vomiting. In addition, the Skunk vehicle shoots the liquid in a strong jet whose force can cause significant harm.

In the summer of 2014, the Israeli police first used the Skunk as a crowd-control weapon in East Jerusalem in response to demonstrations and violent clashes between the police and large groups of Palestinians across East Jerusalem (it had been used previously only by the army in the West Bank against Palestinian demonstrators).

Between July and December 2014, the police covered the narrow and crowded streets in many neighbourhoods of East Jerusalem with 170 tons of Skunk-containing water. Most of the liquid was aimed towards residential properties, cars and shops, causing serious and long-term damage

to property. As a result, the daily lives of tens of thousands of East Jerusalem residents were affected, compelling them to live with this foul and suffocating stench for days at a time. Many families were compelled to evacuate rooms or even entire homes for several days, since it was impossible to breathe, eat, or sleep. Residents also reported feeling deep humiliation, as the stench covered their houses and streets, shutting down businesses and causing stigma. Jawad Alamy, a resident of the a-Tur neighbourhood, related that on July 13, 2014, Skunk liquid was sprayed directly at the windows of his third-floor home. The windows were closed, but drops of the substance penetrated the window frame and Alamy’s 14-year-old son, who was standing next to the window, came into contact with the substance and suffered a rash and irritation on various parts of his body.

On October 26, 2014, Skunk liquid was sprayed into the home of Abed El Razak in Jerusalem’s Silwan neighborhood while he and his six children, the youngest of whom is three years old, were sleeping. The window of Razak’s home was broken and Skunk liquid was sprayed towards the house, forcing the family to leave the home. For several days thereafter, the family had difficulty sleeping at home due to the terrible smell.



VIPIN KUMAR/HINDUSTAN TIMES VIA GETTY IMAGES

Police use water cannons on the activists of various student organisations during a protest outside HRD Ministry Office at Shashtri Bhawan demanding the resignation of the Hyderabad University vice-chancellor over the suicide of a Dalit scholar Rohith Vemula on January 18, 2016 in New Delhi, India.

HEALTH EFFECTS

Water cannons can affect the health of individuals in a number of ways. All water cannons douse protesters in water. In colder climates, this may cause hypothermia and frostbite, particularly if appropriate medical and warming services are not easily accessible. High-pressure water can cause both direct and indirect injuries. Direct injuries may include trauma directly to the body or internal injuries from the force of the water stream.⁶¹ The blunt force used by water cannons can cause indirect injuries from forced falls and slipping on the water. Added chemical agents may also have negative health effects.

Because of the limited literature on water cannons and scarcity of medical literature on injuries, it was not possible to conduct a full systematic review of the injuries caused by water cannons. However, from a review of articles identified in the systematic search and data published in secondary sources, a number of cases of serious injury directly and indirectly caused by water cannons were identified.

Direct injuries from the force of the water striking a person have been reported. One article documented “reduced visual acuity bilaterally, extensive eyelid ecchymosis,

subconjunctival hemorrhages, hyphema, iris sphincter rupture, transient increase in intraocular pressure” in three people with direct high-pressure water trauma to the face.⁶² Most notably, in 2010 a protester in Stuttgart, Germany, (Dietrich Wagner) was hit directly in the face by a high-pressure water cannon from an estimated 15-metre distance.⁶³ He sustained facial bone fractures and lacerations of his eyelids as well as open globe injuries in both eyes, resulting in total blindness in one eye and 95 percent blindness in the other. In a case in May 2015, Chilean student Rodrigo Aviles suffered head injuries after he was knocked over by water cannons. Carabineros (Chilean Military police) sprayed the water point-blank, directly targeting Aviles’ body and at a distance of less than five metres. He was admitted to the hospital with a serious head injury (subdural hematoma). After being in a coma, Aviles finally recovered.⁶⁴

In addition to these cases, there are several documented cases of secondary facial fractures and bony and musculoskeletal injuries from falls and trauma secondary to the force of the water. In 30 cases of injury from water cannons in Turkey, injuries varied in intensity based on the pressure, distance, and duration



SASCHA SCHUERMANN/GETTY IMAGES

Above: Police use a water cannon to control supporters of Pegida, Hogesa (Hooligans against Salafists) and other right-wing populist groups as they protest against the New Year's Eve sex attacks on January 9, 2016 in Cologne, Germany.

of exposure as well as from collisions, falls, or being swept away.⁶⁵ A 2004 report by the British government reviewed water cannon injuries and identified reports citing eye irritation, head and neck injuries, bruises, and rib fractures, primarily from falling or being thrown against objects.⁶⁶ There are also several videos on social media sites documenting water cannons directly hitting people, causing them to fall, rendering them unconscious, or causing traumatic injuries.⁶⁷ Occupational injuries to law enforcement officers during training included accidental musculoskeletal injuries from close-range exposure.

Another type of water cannon usage occurs when the water is mixed with malodorous compounds, thought to be toxic ammonia produced in the fermentation of yeast and sodium bicarbonate. This has been documented to cause nausea, vomiting, and headaches, and has the additional concern of remaining present for several days or more, raising the risk of longer-term toxicity.⁶⁸ This research did not identify specific injuries secondary to this type of deployment, but there are significant human rights concerns

with collective punishment and surreptitious identification and targeting of peaceful protestors. The most notorious case of this type of water cannon is the Skunk, which has been used in Israel.

While evidence on the health impacts of water cannons illustrates the medical concern for serious injury, there are also significant practical, legal, and human rights concerns. Practically, the water cannon is a truck-mounted machine operated from inside a closed elevated cab. Communicating with protestors, hearing their responses, and assessing imminent danger have been noted to be difficult.⁶⁹ We also note that the imposing size and shape of water cannons may intimidate protestors, perhaps purposefully, causing increased panic and, potentially, stampedes.⁷⁰ Water cannons are inherently indiscriminate, particularly at longer distances. The added collective punishment of utilising coloured dyes, ultraviolet marker pigments, or malodorants only serves to highlight the potential for abuse of water cannons. (For specific recommendations on water cannons, see page 89).

“THE ADDED COLLECTIVE PUNISHMENT OF UTILISING COLOURED DYES, ULTRAVIOLET MARKER PIGMENTS, OR MALODORANTS ONLY SERVES TO HIGHLIGHT THE POTENTIAL FOR ABUSE OF WATER CANNONS”

ENGLAND: THE CAMPAIGN AGAINST WATER CANNONS

Following riots in London and other parts of the United Kingdom in August 2011, British policing bodies began consulting on the introduction of water cannons to England and Wales. Water cannon advocates claimed that the police in England and Wales were missing a vital tool in their capabilities. They also relied on the deployment of water cannons in Northern Ireland to justify their extension to England and Wales. In March 2014, the National Policing Lead applied to the government for water cannons to be authorised for all 43 forces in England and Wales.

Against this background, Liberty campaigned against the introduction of water cannons. A civil society coalition, No to Water Cannon, was established, and more than 200 people attended a contentious public meeting on the issue convened by the Metropolitan Police. Liberty argued that water cannons are a highly dangerous, blunt weapon with the potential to cause grievous injury and even death. It argued that their introduction would change the nature of British policing and damage the delicate relationship between the police and the communities they serve. Liberty asserted that the deployment of water cannons would chill protest and free speech – particularly for the young, disabled, and elderly – and would be counterproductive in meeting contemporary public order challenges. In addition, Liberty pointed out the tactical limitations of water cannons. They are slow and unwieldy, and would be practically useless in the narrow Victorian streets that make up vast swathes of Britain’s towns and cities.

The clear divergence of views within the police further hampered the case for water cannons. In the immediate aftermath of the riots, several senior chief constables said that water cannons would have had no impact on the situation, given the spontaneous, fast-moving nature of the disorder. Instead, there was broad consensus that the increase in police numbers on the streets had effectively brought the situation back under control. Five of the six largest police forces stated publicly that they would not deploy water cannons even if they were authorised to do so.

Finally, in July 2015, the Home Secretary announced to Parliament that she was rejecting the police application to authorise water cannons. She gave three reasons. First, that the medical and technical issues raised by the review showed that water cannons pose a series of medical risks, including the potential to cause spinal fracture, concussion, eye injury, and blunt trauma. She cited the case of Dietrich Wagner, a 66-year-old protester in Stuttgart who was completely blinded by water cannons in 2010. Second, she rejected the operational case for water cannons in fast moving and riot situations. Third, she critiqued the impact of water cannons on “public perceptions of police legitimacy,” and suggested that “in areas with a history of social unrest or mistrust of the police, the deployment of water cannon has the potential to be entirely counterproductive.”

3.4

DISORIENTATION DEVICES (FLASH-BANG OR STUN GRENADES)

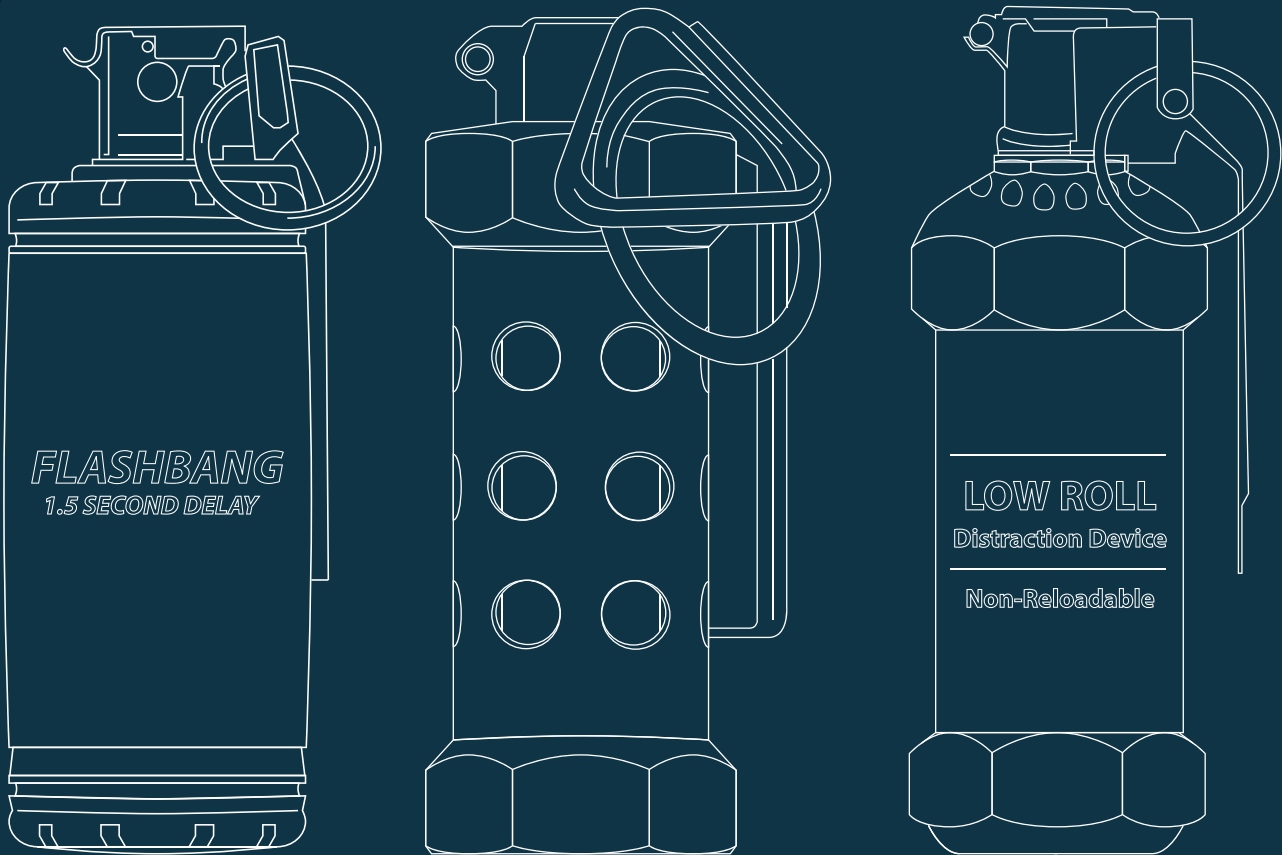

ILLUSTRATION BY KALE VANDENBROEK

WEAPON PROFILE

Disorientation or concussion devices, also known as flash-bang or stun grenades, are weapons that function by creating a loud explosion and/or a very bright flash of light. Flash-bang explosive devices were initially developed by the British Special Air Service in the 1960s and have been used for military combat training for decades.⁷¹ The first documented use of these devices outside of training was at Entebbe, Uganda in 1976, when the Israeli army used them in efforts to rescue hostages.⁷² They were used in 1977 in Mogadishu, Somalia, and at a siege of the Iranian embassy in London in 1980.⁷³ Transition from military operations to police use occurred slowly over time. Use in urban settings and on civilian

populations altered how the weapons were used, as well as the resulting injuries. Specialised law enforcement agencies like Special Weapons and Tactics (SWAT) initially developed similar weapons to use in hostage situations.⁷⁴

Use of stun grenades in crowd control has increased significantly over the past several years, and now these weapons are manufactured by dozens of companies worldwide. With poor regulation and almost no quality control, defective and misfiring stun grenades have been identified in several settings where there were limited regulations or guidelines on use.⁷⁵



MECHANISM OF ACTION

Flash-bang or stun grenades are usually constructed like a conventional grenade, with explosive powder that ignites when struck by a fuse. A key is removed and the object is then thrown, exploding after about a 1.5-second delay. A spark then creates a small flame that causes the explosion of magnesium-based pyrotechnic chemicals. This produces a very bright flash and a loud “bang” at 160 – 180 decibels. Parts of the device can burst and travel as shrapnel. Both the flash and the bang usually last less than one second, momentarily activating photoreceptor cells in the eye and causing blindness for about five seconds until the eye restores itself to its normal, unstimulated state. The loud blast causes temporary loss of hearing and loss of balance, as well as a sense of panic.⁷⁶

HEALTH EFFECTS

Despite their frequent use in civilian police operations, stun grenades carry a high risk of injury. They are primarily used to disorient and incapacitate groups. The results of this review suggest that these weapons are often used in conjunction with chemical irritant canisters, presumably to accelerate crowd dispersal, but they typically result in panic and serious injuries. Recent reports document more than 50 cases of severe injuries and deaths from the use of these weapons, and highlight the risks of indoor use and use in dense crowds.⁷⁷

As with all explosives, stun grenades carry the risk of blast injury. These injuries are complex and result from the pressure waves created by the blast. The weapons are made of both metal and plastic parts that may fragment during the explosion and act as shrapnel. Blast injuries from close proximity explosions can lead to amputation, fractures, and degloving injuries (extensive skin removal that exposes underlying tissue), while secondary injuries produced from fires include asphyxiation, heart attacks, and internal bleeding. Defective and poorly designed weapons may play a role in injury severity.⁷⁸



AHMAD GHARABLI/AFP/GETTY IMAGES

Palestinians collect rubber bullets and stun grenades reportedly used by Israeli riot police outside the Dome of Rock at Al-Aqsa mosque in Jerusalem's Old City after clashes erupted at the compound between Palestinians and Israeli police on September 13, 2015.

Figure 10: Blast Injury

TYPE OF BLAST INJURY	CAUSE	OUTCOME
Primary Blast Injury	Supersonic pressure shock waves from the blast.	Internal injuries, especially of delicate membranes like the eardrum and the lung membranes.
Secondary Blast Injury	Explosion and fragmentation of objects.	Blunt and penetrating trauma from explosive devices.
Tertiary Blast Injury	Displacement of air causes blast wind that can push people into solid objects.	Blunt and penetrating trauma, including fractures and head trauma.
Quaternary Blast Injury	Miscellaneous injuries caused by other parts of the explosion.	Burns, respiratory injuries from flames and smoke, crush injuries, eye injuries, psychiatric trauma (PTSD).

Left: An Israeli soldier throws a stun grenade towards Palestinian protesters on April 10, 2015, during clashes near the Ofer Israeli military prison, after a march by young Palestinians to protest the building of Israeli settlements on Palestinian occupied land.

CANADA: STUN GRENADE BLINDS STUDENT PROTESTER

In the spring of 2012, the province of Quebec experienced widespread unrest among students opposed to a government-proposed university tuition hike. The student movement, popularly referred to as the Maple Spring [or “Printemps Érable”], spearheaded almost daily marches, sit-ins, and a general strike by many students at postsecondary institutions.

On March 7, 2012, the Montreal Police (otherwise known as the Service de Police de la Ville de Montréal, or “SPVM”) detonated nine stun grenades while trying to police a student protest.⁷⁹ A young student protester claimed that one of the stun grenades had been thrown into the crowd and detonated right above him, sending a piece of shrapnel into his eye.⁸⁰ The 22-year-old visual arts student had to undergo surgery for a detached retina and finally lost vision in his right eye. Another protester, who was nearby, suffered burns and bruising from the same blast.⁸¹ The SPVM refused to conclude that a stun grenade had caused the students’ injuries.

The student who lost the use of his eye has launched a lawsuit against the SPVM and the City of Montreal, seeking CND \$350,000 in damages. The student alleges that the police misused the weapons by failing to warn protesters properly before the detonations, and by detonating the stun grenade too close to the protesters.

In 2014, the Quebec government convened a special commission, headed by former member of parliament Serge Menard, to look at the actions of the police during the Maple Spring. Witnesses testifying to the Commission stated that the stun grenades had the effect of inciting protesters to violence and making them feel as though they were being attacked, instead of encouraging the crowds to disperse peacefully.⁸² The Commission concluded that the use of stun grenades by the SPVM was repressive and unnecessary.⁸³ Amnesty International said the SPVM’s use of stun grenades during the Maple Spring was an example of excessive force.⁸⁴



Right: Students protest a hike in tuition fees on June 22, 2012 in Montreal, Canada.



“MANUFACTURING GUIDELINES INDICATE THAT STUN GRENADES CAN BE THROWN INTO HOUSES OR OTHER BUILDINGS TO DISORIENT TARGETS BEFORE THE ENTRY OF LAW ENFORCEMENT/MILITARY PERSONNEL, BUT THERE HAVE BEEN NUMEROUS CASES OF FIRES LEADING TO SIGNIFICANT INJURIES DURING THIS TYPE OF USE.”

In addition to injuries caused directly from the blast, numerous secondary, tertiary, and quaternary injuries can also occur. The concussive blast of the detonation can injure, and the heat created can ignite flammable materials such as fuel. Manufacturing guidelines indicate that stun grenades can be thrown into houses or other buildings to disorient targets before the entry of law enforcement/military personnel, but there have been numerous cases of fires leading to significant injuries during this type of use.⁸⁵ In addition, the confusion and panic caused by stun grenades can also lead to serious injuries, particularly in dense crowds. Though we did not find any systematic or medical assessment of these cases, there are frequent news reports of and anecdotal references to injuries and deaths from stun grenades.⁸⁶

A Propublica report in 2015 documented more than 50 cases of death and serious injury from law enforcement use of stun grenades since 2000 in the United States alone.⁸⁷ Many of these cases were caused by launching stun grenades into people’s homes. In one notable case, an 18-month-old boy sustained a chest wound so deep it exposed his ribs and

severe third-degree burns that required him to be placed in a medically-induced coma, endure weeks of ICU-level care, and undergo numerous skin grafting surgeries after a stun grenade was thrown into his crib during a raid into his home.⁸⁸ In 2003, a 59-year-old woman died from a heart attack when a “concussion grenade” was thrown into her home in New York City.⁸⁹ Notably, 18 U.S. military, corrections, or police officers have sustained serious injuries while handling the weapons. In 2011, a U.S. SWAT officer died of massive internal bleeding when a stun grenade exploded in his hand while he was checking it.⁹⁰

The use of stun grenades for crowd control is an example of the inappropriate and inadequate use of military weapons for crowd management. While the stated objective of stun grenades is to cause disorientation and a sense of panic, the potential for blast injuries caused by the pressure of the blast or by shrapnel from the fragmentation of plastic and metal constituents of the grenade is disproportionately high and it could even lead to death – as has been documented. Therefore, these weapons have no place in effective crowd management, intervention, and control.



ALEXANDER JOE/AFP/GETTYIMAGES

SOUTH AFRICA: THE USE OF STUN GRENADES AT MARIKANA

On August 16, 2012, 34 protesting mineworkers were shot and killed by members of the South African Police Service (SAPS) near a platinum mine owned and operated by Lonmin Plc. in Marikana, a platinum mining town in the North-West province of South Africa.

In the lead-up to what is known as the Marikana Massacre, about 200 mineworkers and members of the SAPS clashed three days earlier in an open bushveld area following the discharge of stun grenades and tear gas by members of the SAPS. Three protesters and two members of the SAPS were killed as a result of the clash.

During the Commission of Inquiry (Marikana Commission) that followed the tragedy, a SAPS colonel – who was flying above the scene of the first incident in a helicopter – testified that after a stun grenade was fired at the group of protesters, the protesters turned around and stormed towards members of the SAPS. The colonel testified further that, notwithstanding the effect of the initial stun grenade, he ordered the helicopter pilot to fly low so that the protesters could be scared and a further 10 stun grenades and 20 tear gas canisters could be fired at them.

CCTV footage introduced as evidence before the Marikana Commission, however, showed

the protesters walking across the open bushveld area and then scattering in different directions following the discharge of the initial stun grenade. Further evidence also showed that, following the clash, the SAPS started drafting a comprehensive operational plan and began deploying specialised policing units to the area to police the broader group of approximately 2,000 protesters. Three days later, 34 protesters were shot dead and 78 were injured following the discharge of live ammunition by the SAPS. No members of the SAPS were killed or injured on that day.

Ultimately, the Marikana Commission found in its final report that “[n]o one has been able to give a proper account of the attack” but that “the use of tear gas and stun grenades [on Monday, August 13, 2012] are not in dispute.” International policing expert Eddie Hendrickx went one step further by submitting to the Marikana Commission that the clash on the afternoon of August 13 “changed the dynamic of the protest.”

It is widely believed that the discharge of the stun grenade in the Monday clash led to the escalation in violence on that day and to an increase in tensions between the protesters and members of the SAPS. These tensions may have significantly contributed to the mass shootings three days later.

3.5

ACOUSTIC WEAPONS

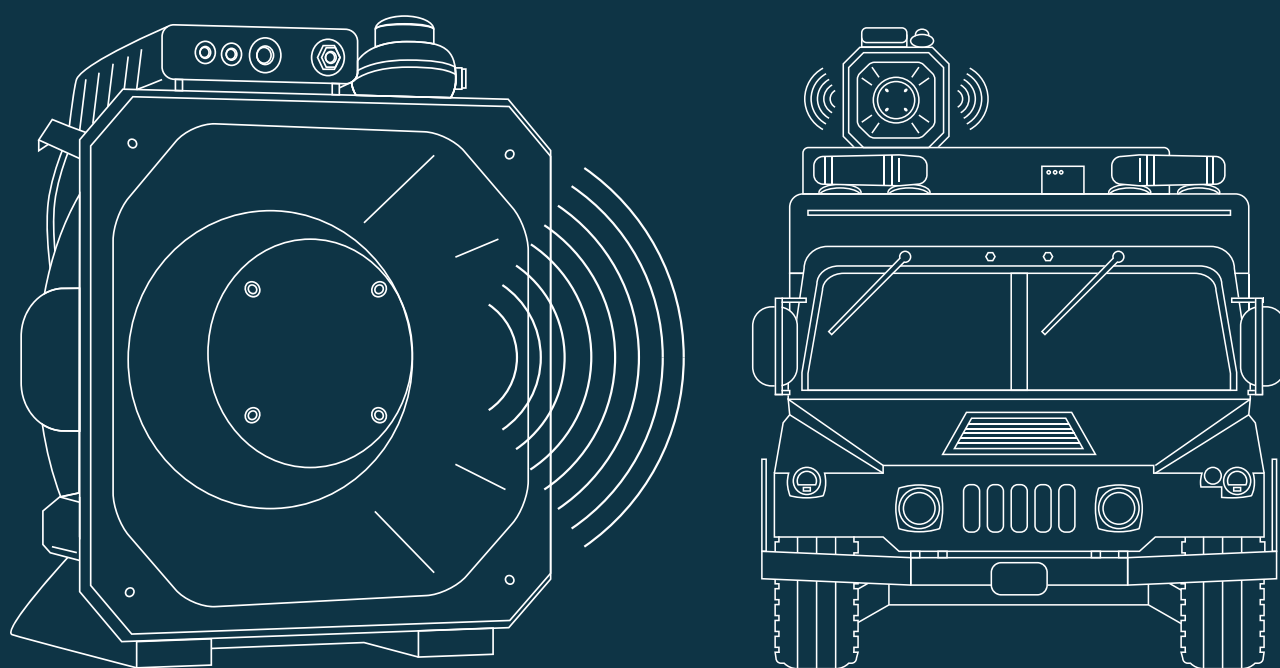

ILLUSTRATION BY KALE VANDENBROEK

WEAPON PROFILE

Acoustic or sonic weapons (also known as long-range acoustic devices, sound cannons, acoustic weapons, sonic bullets, and noise bazookas) are devices that deliver very loud sound over long distances. They can be designed to deliver painful audible or inaudible sound waves, or to act more like very loud voice amplifiers to deliver voice messages or other sounds.

This technology has only been used for crowd-control purposes since the early 1990s. Speciality devices that are able to project loud sounds over very long ranges were originally developed by the LRAD (Long Range Acoustic Device) Corporation;⁹¹ several other companies,

including Hyperspike, now sell the weapons as well. The U.S. military first used acoustic weapons in Iraq in 2004. In October 2009, LRADs were credited with successfully deterring Somali pirates from attacking an American ship,⁹² but there are differing accounts that claim the acoustic weapon was not particularly effective. According to the LRAD Corporation, these weapons are sold to the governments of more than 60 countries. Since the 1990s, the U.S. military and private companies have also researched infrasonic devices that could have effects and cause behaviour changes at very low frequencies that might not be heard by the human ear.



MECHANISM OF ACTION

Acoustic weapons function by delivering loud, painful, and even dangerous levels of noise. In comparison with conventional speakers, acoustic weapons use hundreds of modern (piezoelectric) transducers to create highly concentrated and amplified sound. The sound waves amplify sound in the middle of the wave and cancel out noise outside of the wave so that the sound can, in theory, be directed in a 30-degree beam width. This fairly narrow beam is intended to target the sound but limit its capacity to affect bystanders.

The LRAD brand weapon has a range of 8,900 metres for intelligible speech and a maximum output of 162 decibels (dB) at one metre and can cause pain (110 – 130 dB) at 20 metres.⁹³

A different form of acoustic weapon is the “Mosquito,” which emits very high-pitched sounds that are audible and painful to younger people (teenagers and those in their 20s), while leaving older people (30s and older) unaffected.⁹⁶ This ultrasonic device is used in several countries, primarily in private security settings, despite ongoing litigation. Countries where it is used include Australia, Canada, Denmark, France, Germany, Italy, Spain, Switzerland, and the United States.

An infrasonic weapon is a newer technology that is currently being researched. This device would deliver very low frequency sounds (2 – 15 Hz), which would be inaudible but could cause pain and presumably result in crowd dispersal. These infrasonic weapons have not yet been used, but they provide an example of developing technologies that act on pain receptors.

“**SOUND CANNONS ARE USED TO EMIT PAINFUL, LOUD SOUNDS THAT HAVE THE POTENTIAL TO CAUSE SIGNIFICANT HARM TO THE EARDRUMS AND DELICATE ORGANS OF THE EARS AND/OR CAUSE HEARING LOSS.**”

Figure 11: Example of Acoustic Weapon Capability⁹⁵

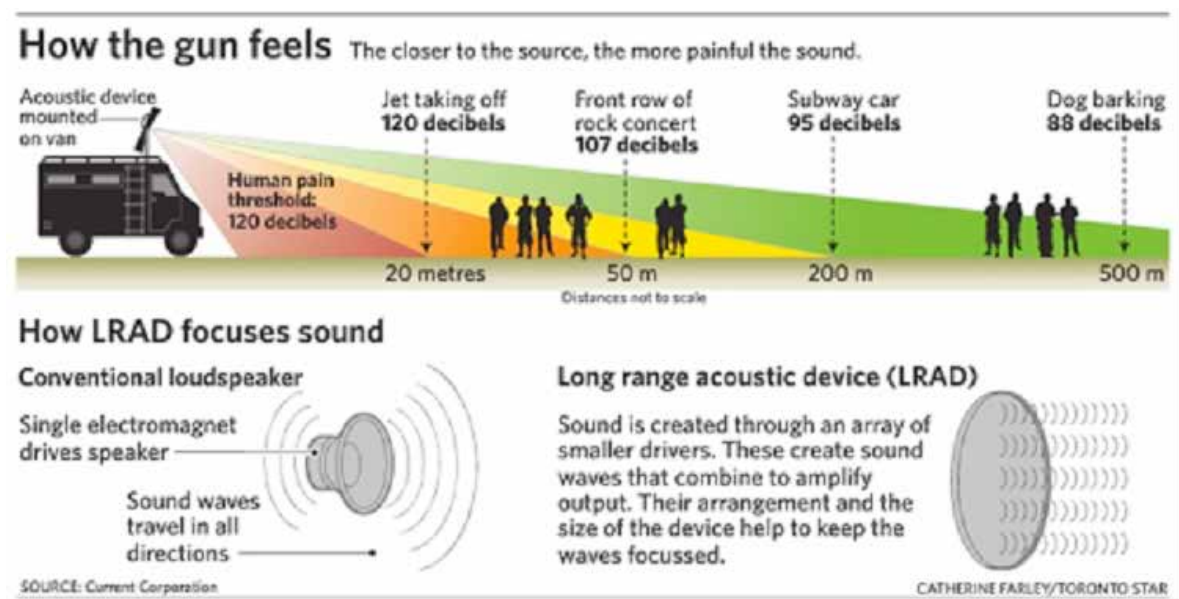

Left: June 3, 2010 Police demonstrate the Long Range Acoustic Device (LRAD) at the Toronto Police College during a technical briefing held by the Integrated Security Unit for the G20.

ACOUSTIC WEAPONS IN THE UNITED STATES: FROM THE G20 SUMMIT TO THE BLACK LIVES MATTER PROTESTS

The first documented use of a long-range acoustic device (LRAD) against protesters in the United States was during the G20 Summit Meeting protests in Pittsburgh, Pennsylvania, in September 2009.⁹⁸ Karen Piper, then a visiting professor at Carnegie Mellon University, sustained permanent hearing loss, tinnitus (ringing of the ears), barotrauma, ear pain, and disorientation when the LRAD was activated without warning in an apparent attempt to disperse protesters. Piper was watching the demonstration in a park, and she reported that the LRAD was mounted on a vehicle 30 metres away and emitted a continuous piercing sound for a number of minutes, causing intense pain as fluid discharged from her ears.⁹⁹ She also became nauseated and dizzy, and developed a severe headache.

On behalf of Piper, the American Civil Liberties Union (ACLU) sued the Pittsburgh Police Department, which settled the lawsuit and agreed to develop a policy for the use of LRADs. Also during the G20 Summit protests in Pittsburgh, police illegally disrupted a peaceful gathering and arrested more than 100 people who were trying to obey a police order to disperse, but became trapped by the 1,000 riot police encircling the area. Police used excessive force during the arrests, gratuitously using pepper spray and shooting people with pepper-ball bullets.

Since then, police have repeatedly used LRADs against protesters in the United States. In November 2011, New York Police Department (NYPD) officers reportedly deployed a hand-held LRAD in short five-second blasts at Occupy Wall Street protesters as the protesters sang the U.S. national anthem.¹⁰⁰ In July 2014, police used an LRAD to disperse a group of protesters in Detroit who were holding a rally to demonstrate against water shutoffs. The LRAD noise blast was deployed for about two minutes, and protesters reported feeling

vibrations throughout their bodies.¹⁰¹ During the August 2014 demonstrations in Ferguson, Missouri, to protest the fatal shooting of black teenager Michael Brown by a white police officer, police activated and pointed a long-range acoustic device at a group of stationary protesters, without warning, for about 15 minutes, and from a distance of 4.5 metres.¹⁰² The truck-mounted model that was apparently used against protesters in Ferguson, the LRAD-500X-RE, can reach 149 dB at a distance of one metre, a level that can cause permanent hearing damage. Then, in December 2014, according to video and eyewitness accounts, the NYPD used a hand-held LRAD-100X model in New York at close range against protesters protesting the failure to indict the police officer who killed Eric Garner.¹⁰³ Police alternated between using the LRAD as a megaphone to make announcements and using its crowd-dispersal alarm to emit pain-inducing noise blasts, firing the noise blasts more than 15 times within three minutes, frequently in several-second blasts, with some blasts lasting more than 10 seconds.¹⁰⁴ Journalists exposed to the LRAD reported symptoms including migraines and ringing of the ears that lasted for a week.¹⁰⁵

Sales of LRADs to U.S. police departments have grown since the wave of Black Lives Matter protests around the United States protesting police killings of African-Americans, raising concerns that the inappropriate deployment of LRADs against protesters will only increase.¹⁰⁶

Top: A woman chants during a march that began at Arsenal Park in Lawrenceville and tried unsuccessfully to make its way to the Convention Center, Downtown, on Thursday, September 24, 2009 in Pittsburgh, Pennsylvania, United States.

Bottom: Protesters plug their ears September 24, 2009 as police use a sonic weapon against an unpermitted protest march that began at Arsenal Park in Lawrenceville during the G-20 summit.



© PITTSBURGH POST-GAZETTE, 2016, ALL RIGHTS RESERVED. REPRINTED WITH PERMISSION. PHOTO BY MICHAEL HENNINGER



© PITTSBURGH POST-GAZETTE, 2016, ALL RIGHTS RESERVED. REPRINTED WITH PERMISSION. PHOTO BY MICHAEL HENNINGER



ANGELO MERENDINO/GETTY IMAGES

Demonstrators march on Ontario St. on December 29, 2015 in Cleveland, Ohio, following a grand jury's failure to indict a Cleveland Police officer for the fatal shooting of Tamir Rice.

HEALTH EFFECTS

Sound cannons are used to emit painful, loud sounds that have the potential to cause significant harm to the eardrums and delicate organs of the ears and/or cause hearing loss. Use of earplugs or firmly blocking the ears with hands can decrease the sound by 20 – 30 dB, but this may not be enough to avoid significant injury. Manufacturer guidelines indicate that sound cannons should only be used from at least a 10 – 20 metre distance.⁹⁷ Significantly, there is a risk of injury to law enforcement officers, particularly those operating the device, who are advised to wear ear protection. In addition to auditory effects, acoustic weapons may also injure internal membranes (infrasonic devices).

There is little medical literature on the effects of acoustic weapons on people. Some literature notes that acoustic weapons were first developed by the military and any early evaluations of their health effects are biased and, in some cases, have unclear findings. The weapons can be indiscriminate, causing harm or pain to protesters, bystanders, and law enforcement, despite the narrow beam in which sound is concentrated. The sound is designed to be controlled by police officers, who can alter the frequency, level, quality, and length of the alarm. Abuse or lack of operator knowledge about the health effects can easily lead to incorrect use of the weapon and exacerbate injuries. Serious questions remain about the safety and efficacy of acoustic weapons in crowd-control contexts.

“THE WEAPONS CAN BE INDISCRIMINATE, CAUSING HARM OR PAIN TO PROTESTERS, BYSTANDERS, AND LAW ENFORCEMENT, DESPITE THE NARROW BEAM IN WHICH SOUND IS CONCENTRATED.”

CANADA: AUTHORISING THE USE OF LRADS AT THE G20 SUMMIT

Prior to the G20 Summit held in Toronto, Canada, in the summer of 2010, the Toronto Police Service (TPS) and the Ontario Provincial Police (OPP) purchased long-range acoustic devices (LRADs) for possible use during the summit. There are provincial laws that require approval of new weapons by the Solicitor General and require that weapons conform to certain standards, but both the TPS and OPP did not seek approval, taking the position that the LRAD is a communication device and not a weapon requiring approval. In addition, both police forces relied on the manufacturer's representations and information regarding the effects of the LRADs and their performance. No independent testing was done.

The Canadian Civil Liberties Association (CCLA) learned of the potential for use of the LRADs as weapons and the failure to obtain the approval of the Solicitor General or of the civilian police services board that oversees the TPS. CCLA was aware that many large-scale protests were planned during the summit and it had planned to send monitors to observe the protests and the police response. Just prior to the summit, CCLA applied for a court order preventing the police from using the alert and communication functions of the LRAD at levels above those prescribed by provincial occupational health and safety legislation. As a result of the court application, the OPP did some field tests of the

LRADs and retained an acoustician to do his own tests. None of the tests was conducted in an urban environment similar to the one where the LRADs might actually have been used during the summit. In addition, while both police services had developed standard operating procedures for use of the LRADs, those procedures changed as the evidence for the court case unfolded. The OPP had developed more cautious crowd separation distances and lower maximum volume levels for use of the alert function than the TPS.

The judge who heard the CCLA's application granted it in part. In essence, he found that the TPS procedures for use of the alert function did allow for the exposure of demonstrators to an undue risk of hearing damage. He did not have the same concern about the OPP's use of the weapon, based on its more cautious guidelines. As a result, the TPS had to change its standard operating procedures and bring them in line with the OPP's. The case served as a springboard for the provincial government ministry responsible for public safety to undertake a review of LRADs, and regulations governing their use were ultimately put in place.

This case highlights the importance of including multiple parties in the process of testing and developing standard operating procedures prior to the deployment of new weapons.

3.6

DIRECTED ENERGY WEAPONS

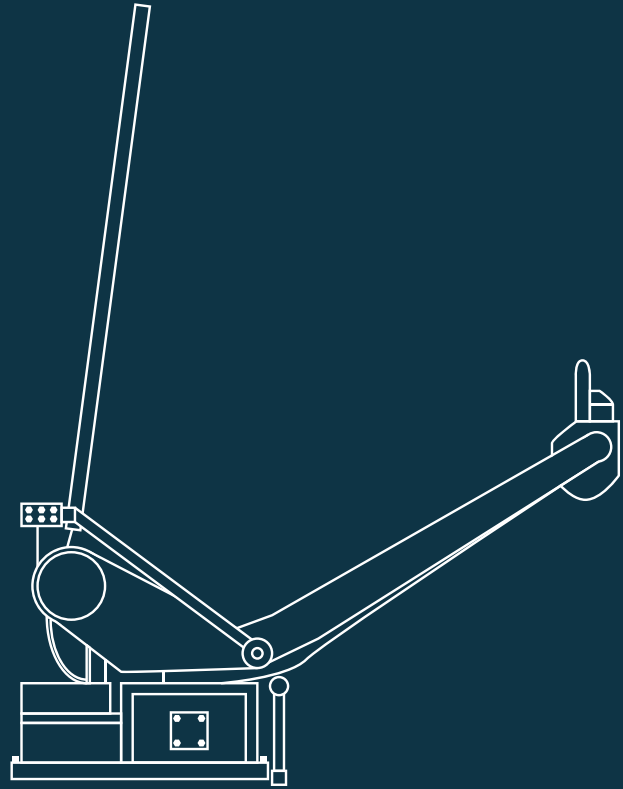
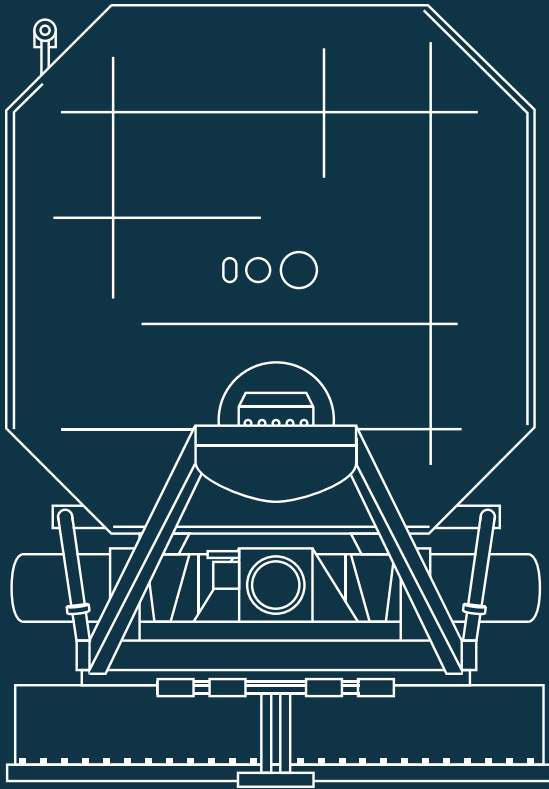

ILLUSTRATION BY KALE VANDENBROEK

WEAPON PROFILE

Directed energy weapons are a newer technology developed by the U.S. military.^z Known as the “active denial system” (ADS), these are electromagnetic heating devices that deliver very high-frequency millimetre wavelength electromagnetic rays that heat skin on contact and cause a painful, burning sensation.¹⁰⁷ These weapons have

not been used in protests to date but are actively in development for crowd-control uses and are being marketed towards law enforcement agencies as well as military agencies.¹⁰⁸ Therefore, even though they are still being developed, we consider it important to include this weapon in this report.

^zThe U.S. Air Force Research Laboratory and the U.S. Department of Defense’s Joint Non-Lethal Weapons Directorate initially funded the development of an electromagnetic heating weapon in 2002. By 2004, private manufacturers such as Raytheon were funded to continue research. The first prototype, Active Denial System I, underwent some testing and was deployed in Afghanistan in 2010, but was recalled a few months later and has never been used against enemy combatants in military settings. Since 2011, ADS II, an updated version, and the Silent Guardian, a smaller mobile device, have been demonstrated on military personnel and volunteers. The Silent Guardian has been marketed directly to civilian law enforcement agencies and other security providers.

MECHANISM OF ACTION

Directed energy weapons project a focused beam of electromagnetic waves at a high frequency (95 gigahertz (GHz)) and very short wavelength, making them capable of penetrating superficial skin layers (0.5 mm). By comparison, a microwave oven operates at 2.45 GHz and has a much longer wavelength, of several centimetres, which allows for greater penetration of material and efficiency in heating food. Directed energy weapons are considered non-ionising, meaning they purportedly do not have the capability to alter cellular structure. The ADS is intended to produce a skin surface heating sensation similar to, but more severe than, infrared energy from the sun.

“BECAUSE THE DIRECTED ENERGY WEAPON HAS NOT BEEN USED IN PRACTICE, LITTLE IS KNOWN ABOUT ITS ACTUAL HEALTH EFFECTS. HOWEVER, RESEARCH ON ELECTROMAGNETIC WAVES OF SIMILAR WAVELENGTH IN SCIENTIFIC STUDIES HAS ILLUSTRATED THAT NON-IONISING HIGH-FREQUENCY RADIATION CAN CAUSE SKIN PAIN AND, POTENTIALLY, BURNS.”

HEALTH EFFECTS

Because the directed energy weapon has not been used in practice, little is known about its actual health effects. However, research on electromagnetic waves of similar wavelength in scientific studies has illustrated that non-ionising high-frequency radiation can cause skin pain and, potentially, burns.¹⁰⁹ Increases in skin temperature trigger thermal-sensitive nociceptors (nerve endings). This sudden exposure of the nerve endings evokes the sensation of pain and intolerable heat.

The thickness of skin is dependent on the body location: skin of the eyelids can be 0.2 mm deep, while skin on a thick part of the back can be 1.5 mm deep. By penetrating about 0.5mm, heat rays can access the skin past the epidermis and into the dermal layer, which contains blood vessels, nerves, glands, and muscle. Depending on the length of time that skin is exposed, there is a risk of skin burns and damage to the dermal organs. Targeting of the eyes or other sensitive areas could theoretically cause more serious injury and blindness.

Actual studies of the ADS in the field have not been conducted.¹¹⁰ Manufacturers claim that they have studied more than 11,000 exposures in 700 human demonstration studies, but most of these studies were conducted using heat lamps rather than actual ADS systems, and few have been published in peer-reviewed literature.¹¹¹

Although little of the data is available for independent review, in a 2008 U.S. military-funded review of the literature, the Human Advisory Panel concluded that though the heat ray is generally safe, there have been skin burns and injuries from inadvertent overexposure to the beams.¹¹² After an Air Force volunteer sustained second-degree burns to 8 percent of his body, a safety investigation found that incorrect power and duration settings were used for that specific scenario. This subject required surgical removal of several blisters and several weeks of medical care. There were at least four other cases of volunteers developing blisters and persistent pain or redness among more than 200 volunteers with 3,500 exposures in three different environments. Investigators also found that wet clothing increases the effects of the heat beam. The advisory panel did not conduct any unique experiments; rather, it evaluated previously conducted experiments and demonstrations on the first-generation Active Denial System I. Since then, there has been no published data on the impact of newer directed energy weapon technologies.¹¹³

Directed energy weapons have not been used in practice and there has been no assessment of their safety in crowd-control settings. The existing information identifies concerns of tissue injury, especially with prolonged exposure or exposure to vulnerable organs such as the eye. There are also practical concerns that utilising an invisible but very painful weapon could exacerbate mistrust or frustration with government forces. The long distances at which the beam can be used may limit the ability of law enforcement to appropriately differentiate violent or threatening individuals from bystanders, or to judge from the responses that the weapon is being used safely.

Right: A US Marine Corps truck is seen carrying a palletized version of the Active Denial System, March 9th, 2012, at the US Marine Corps Base Quantico, Virginia.





UNITED STATES:

MILITARISED POLICE RESPONSE TO PROTESTS IN FERGUSON, MISSOURI



SCOTT OLSON/GETTY IMAGES

Demonstrators, marking the one-year anniversary of the shooting of Michael Brown, face off with police during a protest along West Florissant Street in Ferguson, Missouri on August 9, 2015.

After a white police officer fatally shot unarmed black teenager Michael Brown on August 9, 2014, in Ferguson, Missouri, crowds of citizens gathered near the shooting site and at other locations in Ferguson to protest the shooting and systemic policing problems. The protests continued unabated for two weeks, then occurred periodically until they were renewed following the November 24 grand jury decision not to indict Darren Wilson, the police officer who had killed Brown. Most people were assembled peacefully and were not there to commit any acts of violence, though at times the crowds grew unruly and some individuals became violent or looted.

More than 50 law enforcement agencies responded to the protests in the overwhelmingly African-American community with an aggressive militarised response and show of force. Four core police agencies responded with armoured vehicles mounted with rifle sights, full riot gear, leashed police dogs, shotguns, AR-14 semi-automatic rifles, and M-4 military assault rifles, like those used by U.S. forces in Iraq and Afghanistan.¹¹⁴ Armed snipers trained military assault rifles on unarmed protesters, many of whom stood with their hands up.¹¹⁵ Missouri National Guard forces, deployed to suppress the protests, used military language such as “enemy forces” and “adversaries” to refer to protesters.¹¹⁶ The Department of Justice later found “the use of military weapons and sniper deployment atop military vehicles was inappropriate, inflamed tensions, and created fear among demonstrators.”¹¹⁷

The predominantly white local, county, and state police indiscriminately used vast amounts of crowd-control weapons against protesters and journalists. Police fired a barrage of tear gas – including decades-old, expired tear gas canisters manufactured during the Cold War era¹¹⁸ – and pepper spray, beanbag rounds, sting-ball grenades and canisters, rubber-coated pellets, flash-bang tactical grenades, obscurant smoke grenades, pepper balls, and wooden bullets against peaceful protesters and journalists attempting to document and report on these events.¹¹⁹ Police fired tear gas at protesters with no means of egress, as well as at retreating protesters who were attempting to escape.¹²⁰ Officers also activated and pointed a long-range acoustic device at a group of stationary protesters from a distance of 4.5 metres.¹²¹ An Armament Research Services study of munitions recovered at the protest sites identified 29 different less lethal munitions deployed in August 2014 alone.¹²²

Often these CCWs were used by police without first issuing a clear order to disperse. A Department of Justice investigation concluded that tear gas was “deployed inappropriately without proper warnings, without sufficient attention paid to safe egress, and without consideration for ... potential impact on the safety of citizens.”¹²³

Protesters and journalists sustained injuries from the CCWs, some requiring admission and treatment at local hospitals. In one incident, a church pastor was shot in the abdomen with a rubber bullet while

she attempted to mediate between police and protesters.¹²⁴ The bullet left a large, bloody bruise and deep wound. In another incident, a flash-bang grenade fired at protesters singed a reporter's leg and caused a protester's shirt to briefly catch fire.¹²⁵ At least two children were treated at local hospitals for tear gas exposure, after police used tear gas against groups of protesters that included families with children.¹²⁶

In another incident, police fired tear gas canisters at two journalists attempting to interview a peaceful protester, then shot rubber bullets at them, hitting them in the back as they walked away with their hands in the air and repeatedly identified themselves as members of the press.¹²⁷ Police approached with guns drawn and arrested both journalists.

Legal observers were also targeted. In one incident, police fired more than 15 tear gas canisters at two American Civil Liberties Union of Missouri staff clearly identified as legal observers who had walked about two blocks away from the larger group of protesters. The legal observers were overcome with intense feelings of suffocation and severe eye irritation.

After the August protests, St. Louis County police spent \$172,669 to replenish their stores of crowd-control weapons and equipment in preparation for the November protests following the decision not to indict the officer who killed Michael Brown.¹²⁸

Police also arrested hundreds of protesters for unlawful assembly and failure to disperse.¹²⁹ In the 12 days following the shooting of Michael Brown, 172 arrests were made in the Ferguson protest zone, and 132 people were charged solely with the crime of refusal to disperse.¹³⁰ Following the November 24 grand jury decision not to indict Darren Wilson, protests erupted around the United States, during which police arrested hundreds of demonstrators.¹³¹ In addition, police arrested 24 journalists attempting to cover the Ferguson protests.¹³²

In statements regarding these events, President Barack Obama condemned the excessive use of police force and maintained that "there's also no excuse for police to use excessive force against peaceful protests or to throw protesters in jail for lawfully exercising their First Amendment rights."¹³³

Despite such censure, police departments nationwide have continued to suppress demonstrations against police killings of unarmed black men, with no accountability. Black Lives Matter movement protesters have been arrested and surveilled nationwide, including in Baltimore, Cleveland, Philadelphia, New York, Washington D.C., and again in Ferguson on the one-year anniversary of the killing of Michael Brown.

Right: People hold signs during a memorial service marking the anniversary of the death of Michael Brown on August 9, 2015 in Ferguson, Missouri.





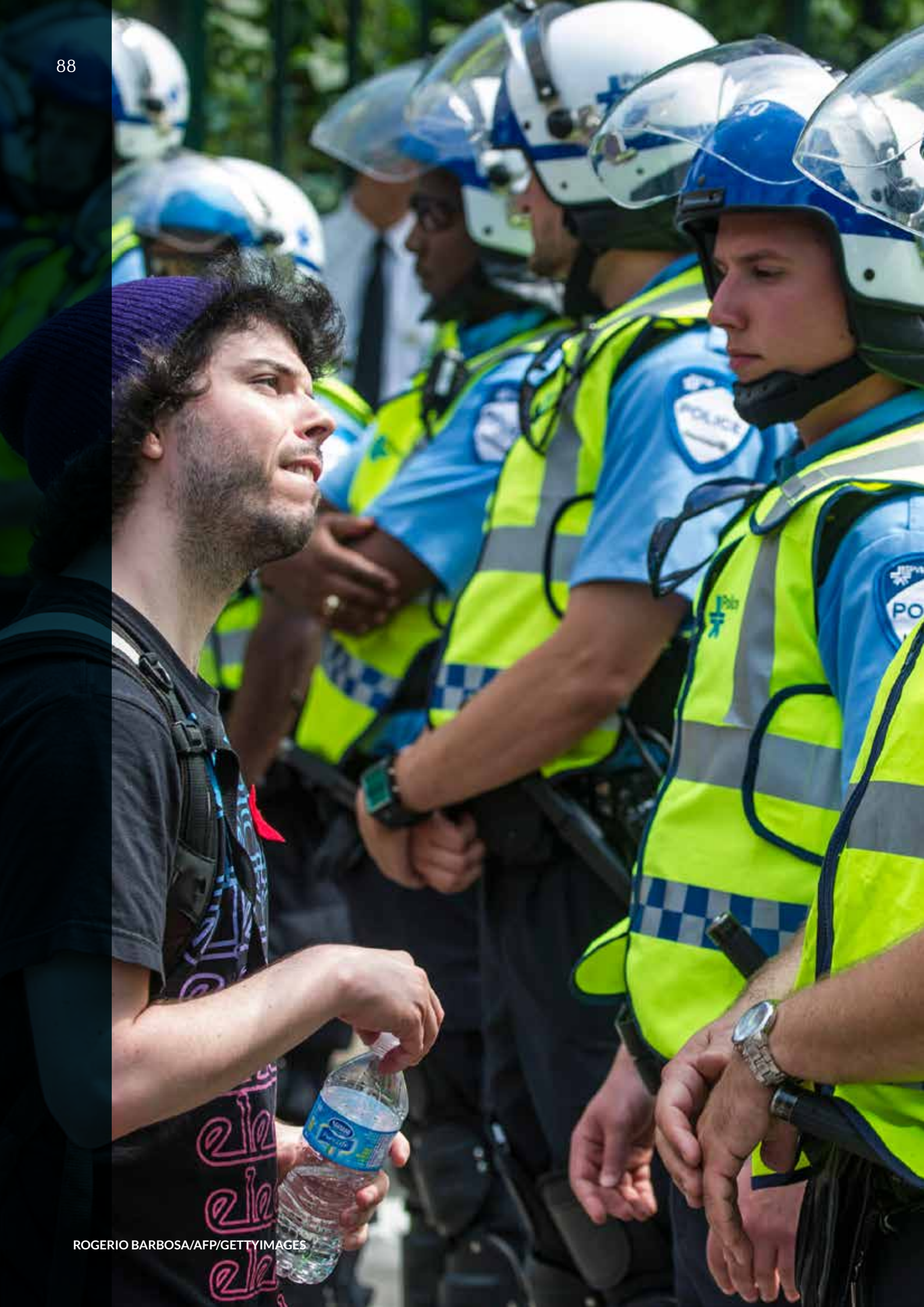

4.0

CONCLUSION AND RECOMMENDATIONS

A number of conclusions and recommendations emerge from the evidence and case studies compiled in this report. These are premised on several core principles:

- In the context of policing protests, the role of the police is to facilitate freedom of assembly and freedom of expression, while ensuring public safety;
- The most effective method to prevent violence in the context of protests is to engage in negotiations and open a dialogue with protesters;
- The use of crowd-control weapons (CCWs) in assemblies should be an absolute last resort when dealing with genuine and imminent threats to the safety of those present, and only after all other means have been exhausted;
- The mere fact that an assembly may be considered unlawful under domestic law does not justify the use of CCWs;
- Even in the context of protests where there are people who either engage in or incite others to engage in acts of violence and which require police intervention, the explicit goal of intervention should be to de-escalate the situation, and promote and protect the safety and the rights of those present – protestors, journalists, medical personnel, monitors, and bystanders;
- If CCWs are deployed, their use should always be necessary and proportionate to the threat faced and to the legitimate aim pursued.

The common understanding of CCWs is that they are non-lethal and preferable to the use of more injurious means of dispersing a crowd. However, this report has shown that these weapons can often result in significant injuries, disability, and even death. As a result, there is a pressing need to engage in further ethical research and empirical studies to develop clear scientific standards and parameters for the use of CCWs. To facilitate this work, states should be required to investigate any injuries or deaths related to the use of CCWs. Through the research we have undertaken, certain patterns of risk emerge.

First, the development of new CCWs and aggressive marketing by companies to law enforcement units is, in some cases, driving demand. These newer weapons are not adequately tested and some have been developed for military purposes. The marketing of such devices in the absence of demonstrated data on safety and effectiveness illustrates the problem of the unregulated proliferation of CCWs.

Second, some of the CCWs that are used are inherently inaccurate and indiscriminate in their effects, risking serious injury and death to the people targeted, other demonstrators, bystanders, and law enforcement officers.

Third, the capacity of CCWs to achieve the goal of safe crowd dispersal is limited. Most CCWs are inherently indiscriminate, and CCWs' infliction of pain and incapacitation typically does not result in the orderly dispersal of protesters. On the contrary, the use of CCWs for crowd dispersal is often counterproductive, as they cause confusion and panic, resulting in additional injuries as well as an escalation of violence.

Fourth, the presumption that CCWs are non-lethal means that police and security personnel are not always trained in the proper use of such weapons, nor are cases of injury and death from their use investigated. On some occasions, CCWs are misused as a result of inadequate training. However, CCWs are also often intentionally misused as weapons for political repression rather than for legitimate

crowd-control purposes. The misuse of CCWs is exacerbated by the fact that they are subject to fewer controls and regulations, due to the common misconception that these weapons are not dangerous.

Against this background, we have laid out recommendations with respect to pre-deployment, deployment, and post-deployment of CCWs in order to develop safe practices for the occasions when these weapons are used.

A. RECOMMENDATIONS FOR PRE-DEPLOYMENT OF CCWS

DESIGN AND TRADE

1. Weapons initially developed for military purposes should not be used for the purpose of crowd control; weapons designed for military purposes are inappropriate unless they have been adapted for crowd-control purposes or tested for appropriateness and effectiveness for that task.

2. Trade controls should be adopted, as they can play an important role in controlling the proliferation and potentially the use of technologies that may be incompatible with the UN Basic Principles and other international standards.

PROCUREMENT AND SELECTION

3. Weapons should be procured based solely on identified operational needs and in light of the domestic context under which law enforcement operates or intervenes in protest activities.

4. While recognising that law enforcement may be in the best position to assess operational needs, procurement decisions must be subject to transparent political oversight, approval, and accountability. Also, procurement decisions should be subject to public consultation.

5. After procurement, but prior to deployment, weapons and ammunition should be clearly identified, inventoried, and stored to facilitate accountability in the post-deployment phase. When weapons and ammunition are distributed

to law enforcement officers, there should be clear means of tracking distribution to individual officers.

6. When the effective decision is made that law enforcement carry weapons in an intervention in a social protest, the selection of these weapons should be based on the environmental factors specific to the situation.

TESTING

7. Testing of new and existing weapons should not be left solely in the hands of manufacturers; governments should test weapons prior to making procurement decisions. Testing, evaluation, and approval should include a multidisciplinary approach that, in addition to law enforcement, includes policy-makers and academics.

8. Testing of CCWs should consider the following factors:

- Legality
- Level of accuracy
- Risk of lethality
- Risk of serious injury or disability
- Level of pain inflicted
- Lifespan
- Reliability (i.e., minimal risk of malfunction)

9. Testing to determine safe distances for the use of CCWs should occur in conditions that are similar to what would be faced in protest situations and under varied scenarios. Factors to consider include urban or rural environment, expected weather conditions, nature of space, size and demographics of crowd, among others.

10. The testing process should inform regulations and guidelines for the lawful use of CCWs.

11. The results from the testing should be made available to the public.

12. Newly acquired weapons should be subject to a pilot program to allow for evaluation and assessment.



“EVEN IN THE CONTEXT OF PROTESTS WHERE THERE ARE PEOPLE WHO EITHER ENGAGE IN OR INCITE OTHERS TO ENGAGE IN ACTS OF VIOLENCE AND WHICH REQUIRE POLICE INTERVENTION, THE EXPLICIT GOAL OF INTERVENTION SHOULD BE TO DE-ESCALATE THE SITUATION.”

SPECIFIC TESTING RECOMMENDATIONS PER TYPE OF WEAPON

13. Chemical irritants: The redesign of chemical irritants to extend half-life, increase resistance to the weather, and continue to cause the target to be exposed to the effects of the agent after the incident must be halted; these goals exceed the objectives of crowd management.

14. Water cannons: More research is needed on thresholds for the safe use of water cannons and to understand the health effects of high-pressure water cannons before authorising their use. Although no estimates were found in the literature of the pressure threshold for safe usage, there have been documented cases where permanent injuries such as blindness and bone fractures were caused by high-pressure water discharge.

REGULATIONS, TRAINING, AND PLANNING

15. Regulations, procedures, and/or protocols should be developed for law enforcement based on applicable domestic and international laws and should reflect the findings from independent testing. Law enforcement should not rely solely on manufacturers' instructions.

16. Regulations, procedures, and/or protocols on the use of CCWs should be publicly accessible and include: when weapons may be used; training requirements; the risks associated with use of these weapons, both individually and in crowd-control situations; and accountability measures.

17. Law enforcement should be trained in the proper use of CCWs. In addition to teaching the technical aspects of the weapon and its use, training should be contextual. While CCWs are used in other policing tasks, training should address the specific aspects and challenges of policing protests.

18. Training should be continuous and ongoing, and should include simulations and exercises that review past cases to identify inappropriate or unlawful weapon use and consider alternative approaches.

19. Law enforcement should be trained in human rights standards, including: their role in promoting and protecting the right to life; the rights to freedom of assembly and freedom of expression; the right to be free from violence and arbitrary arrest; the right to be free from torture and cruel, inhuman, and degrading treatment and punishment; and due process rights.

20. Training should include recognition of firing distances. In the practice of actual police interventions, officers have a hard time identifying and applying firing distances. This should be specifically addressed by the training.

21. Law enforcement officials should be informed of the medical and health effects of CCWs. Training must include information about the effects and risks of each device, when use of a particular weapon is not indicated, and precautions that should be taken in using particular weapons.

22. With respect to chemical irritants, training must include discussion of concentration levels and the fact that the effects of the weapons vary depending on the density of the crowd, duration of exposure, pre-existing medical conditions, and the vulnerability of specific populations.

23. Individuals who have not received the appropriate training (as described above) should not be permitted to carry CCWs.

24. Pre-deployment planning should always consider contextual factors, including the nature of the area where the protest is occurring, whether the protest is static or mobile, the weather conditions, access to exits, and the size and demographics of the crowd, among other factors. Deployment of indiscriminate CCWs against crowds without proper planning can cause mass panic and lead to serious injuries and death.

B. RECOMMENDATIONS FOR DEPLOYMENT AND USE OF CROWD-CONTROL WEAPONS

1. The use of any kind of force, including CCWs, must always meet the tests of necessity, proportionality, legality, and accountability. Law enforcement officials must always aim to use the minimum force necessary in any situation.^{aa}

2. The use of firearms and live ammunition should be entirely prohibited in the context of managing crowds and facilitating protest.

3. When a decision is made to use force in response to acts of violence, law enforcement officials should not treat crowds as a single violent entity because of the actions of some individuals. Law enforcement officials must make every effort to isolate and respond proportionately to violent actions, without unnecessarily interfering with the rights of other protesters.

4. CCWs should not be used without first

warning protesters and giving them time to comply with a lawful order, so that they will not be subjected to the use of weapons that are inherently indiscriminate.

5. If a protest turns violent, the police and security forces should protect those in the crowd who are most at risk of injuries, including children and the elderly, among other vulnerable groups.

KINETIC IMPACT PROJECTILES

- Kinetic impact projectiles (KIPs) in general are not an appropriate weapon to be used for crowd management and, specifically, for dispersal purposes; most cannot be used effectively and safely against crowds. At close ranges, levels of lethality and patterns of injury of some KIPs become similar to live ammunition.

- Indiscriminate KIPs that fire multiple projectiles, such as shotgun pellets and other types of ammunition, should be prohibited in the context of protest. It is virtually impossible to deploy these safely and effectively against crowds or individuals.



SCOTT OLSON/GETTY IMAGES

Police officers hold back demonstrators protesting the G8/G20 summits on June 26, 2010 in Toronto, Ontario Canada.

^{aa} The four tests or basic principles are included in various national codes of conducts and standard operating procedures for police forces. The principle of necessity emphasises that use of force should always be considered an exceptional measure. Proportionality means that use of force must be proportionate to the lawful objective to be achieved and to the seriousness of the offence. Law enforcement agencies must ensure that their actions conform to national laws and regulations and to international human rights standards and that they are accountable through adequate reporting and review procedures.



THIS REPORT HAS SHOWN THAT THESE WEAPONS CAN OFTEN RESULT IN SIGNIFICANT INJURIES, DISABILITY, AND EVEN DEATH. AS A RESULT, THERE IS A PRESSING NEED TO ENGAGE IN FURTHER ETHICAL RESEARCH AND EMPIRICAL STUDIES TO DEVELOP CLEAR SCIENTIFIC STANDARDS AND PARAMETERS FOR THE USE OF CGWS.



- Rubber-coated metal bullets, or other kinds of KIPs that have a metal core, are not safe for crowd control and should be entirely prohibited. By design, these weapons impact targets with excessive energy and higher velocities and have very high potential to cause serious injury and death.
- Some KIPs are able to provide a comparatively less lethal and accurate alternative. Their deployment should be restricted to circumstances where a threat to life or a threat of serious injury exists, and where all other means to protect lives are inapplicable. These should be used minimally and with caution, since they still have high potential to cause serious injury or death.
- KIPs should never be fired at close range and should never be targeted at the head or other vital areas of the body, where impact typically causes serious injury and, in many instances, death.

CHEMICAL IRRITANTS

- Chemical irritants, when deployed using canisters or grenades, are indiscriminate by nature. Caution should be used during deployment to stop the effect from spreading to unintended targets and bystanders, and to minimise the risk of overexposure, which causes increased risk of injury.
- Law enforcement agencies must not exceed the minimum amount of chemical irritant necessary to achieve the effect of

irritation and transient incapacitation. Higher concentrations of chemical irritants, which could easily be achieved by firing multiple canisters in the same spot or repeatedly, could potentially cause serious injury or even death and must be avoided.

- Firing grenades or canisters containing chemical irritants into closed spaces or open space where there is no safe egress should be prohibited, as this significantly increases the risk of serious, unnecessary injury and death.
- Contextual factors must always be considered before making a decision to deploy indiscriminate chemical irritants (i.e., the geographical nature of the deployment site, wind patterns, or the existence of hospitals, schools, or dense, uninvolved populations in the vicinity).
- Mixing more than one chemical agent or dissolving the agent into the liquid used in water cannons increases the risk of injury and its effects have not been properly studied. Such mixtures should not be deployed.
- Firing gas canisters or grenades directly into a crowd or towards individuals must be prohibited.

WATER CANNONS

- Water mixed with dye or a foul odour is not an appropriate mechanism for crowd control and should be prohibited. The primary outcome of these weapons appears to be collective

punishment and humiliation, which are not legitimate policing tactics.

- Contextual factors must be taken into consideration when deploying water cannons, specifically when they are used in cold weather, which leads to the risks of frostbite or exposure.

DISORIENTATION DEVICES

- Firing stun grenades directly into crowds or towards individuals should be prohibited.
- Firing stun grenades for dispersal of crowds is inappropriate, as the risk of unnecessary and serious injury is very high. While the stated objective of stun grenades is to cause disorientation and a sense of panic, the potential for blast injuries caused by the pressure of the blast or by shrapnel from the fragmentation of plastic and metal constituents of the grenade, is disproportionately high and could even lead to death – as has been documented.

ACOUSTIC WEAPONS

- There are very serious concerns about acoustic weapons' high potential to cause serious and permanent injury, such as hearing loss, and the inherent inability of such systems to prevent bystanders and even law enforcement officials from being affected. These concerns are exacerbated by the lack of proper research and evidence about the health effects of acoustic weapons. For these reasons, the use of acoustic weapons in crowd-control situations should be suspended, at least until such concerns are addressed.

DIRECTED ENERGY DEVICES

- Because directed energy devices (DEDs) have not been used in practice and there is no sufficient understanding of their safety in crowd-control settings, such weapons should not be used for crowd management. There are very serious concerns about prolonged exposure, the risk of cellular damage and high degree burns, and the potential for abuse. If these concerns are confirmed, the development and sale of these weapons for law enforcement purposes and especially for crowd control must be halted, as the use of these weapons would be disproportionate by design.

C. RECOMMENDATIONS FOR POST-DEPLOYMENT AND ACCOUNTABILITY

MEDICAL ASSISTANCE

1. Law enforcement should ensure that proper medical assistance is available to provide aid promptly when CCWs are deployed.

ACCOUNTABILITY

2. Law enforcement officials should record and report any use of CCWs, including specific models of CCWs deployed, the distances from the targeted individuals/bystanders and duration of deployment, the number of each type of CCW used, and documented or reported injuries caused by CCWs. Their reporting must demonstrate that the use of CCWs was proportionate, necessary, and legal.

3. Law enforcement officials should wear visible identification to facilitate accountability.

4. There should be a clear chain of command, responsibility, and accountability. All decisions taken should be traceable, and those who have taken them must be held accountable for them.

5. All cases of deaths, injuries, and suspected misuse of CCWs should be thoroughly investigated by a body independent from the unit/department involved, with a view to establishing responsibilities and accountability of the officers involved, including the various levels of the command structure in charge during the incident. Where there is evidence of unlawful conduct, commanders and responsible officers should be liable to administrative disciplinary measures and/or criminal prosecution.

6. Police officers under investigation for misuse of CCWs or for any other abuse of force should be suspended until their case is resolved.

7. Legal provisions should be ensured for victims to obtain redress, even in the absence of a criminal conviction of the perpetrator(s), as well as fair and adequate compensation, including the means for the fullest rehabilitation possible.

ENDNOTES

¹ United Nations Congress on the Prevention of Crime and the Treatment of Offenders, “Basic Principles on the Use of Force and Firearms by Law Enforcement Officials” (United Nations, August 27, 1990), <http://www.ohchr.org/Documents/ProfessionalInterest/firearms.pdf>

² “Kenyan Policemen Tear-Gas Children in Playground Protest,” *Times of Oman*, January 19, 2015.

³ “On the Streets of America: Human Rights Abuses in Ferguson,” Amnesty International USA, accessed April 14, 2015, <http://www.amnestyusa.org/research/reports/on-the-streets-of-america-human-rights-abuses-in-ferguson>

⁴ Patrick Kingsley, “Eye Sniper of Tahrir Square Is in Jail, but Has Anything Changed?,” *The Guardian*, March 6, 2013, sec. World news, <http://www.theguardian.com/world/shortcuts/2013/mar/06/eye-sniper-tahrir-egypt-jailed>

⁵ United Nations Congress on the Prevention of Crime and the Treatment of Offenders, “Basic Principles on the Use of Force and Firearms by Law Enforcement Officials.”

⁶ Omega Research Foundation and Amnesty International, “The Human Rights Impact of Less Lethal Weapons and Other Law Enforcement Equipment” (London, UK: Amnesty International, April 2015), <http://www.amnestyusa.org/research/reports/the-human-rights-impact-of-less-lethal-weapons-and-other-law-enforcement-equipment>

⁷ United Nations, Convention on the Prohibition of the Development, Production, Stockpiling and Use of Chemical Weapons and on Their Destruction, 1994, http://www.opcw.org/index.php?eID=dam_frontend_push&docID=6357; Michael Crowley, “Drawing the Line: Regulation of Riot Control Agents and Incapacitants Under The Chemical Weapons Convention,” Bradford Non-lethal Weapons Project (University of Bradford: Omega Research Foundation, April 2013), <http://www.omegaresearchfoundation.org/assets/downloads/publications/BNLWRP%20ORF%20RCA%20Munitions%20Report%20April%202013.pdf>

⁸ United Nations Congress on the Prevention of Crime and the Treatment of Offenders, “Basic Principles on the Use of Force and Firearms by Law Enforcement Officials.”

⁹ General Assembly, Code of Conduct for Law Enforcement Officials, 1979, <http://www.ohchr.org/EN/ProfessionalInterest/Pages/LawEnforcementOfficials.aspx>

¹⁰ Human Rights Council, “Report of the Special Rapporteur on Extrajudicial, Summary or Arbitrary

Executions, Christof Heyns” (United Nations General Assembly, May 2011), para. 4, <http://www.icnl.org/research/resources/assembly/Report%20of%20the%20Special%20Rapporteur%20on%20extrajudicial%20summary.pdf>

¹¹ *Ibid.*, n. 5.

¹² Inter-American Court of Human Rights, Case of Caracazo v. Venezuela, 2002, para. 127: Inter-American Court of Human Rights, Case of Caracazo v. Venezuela, 2002, n. where the Court stated that the “pretext of maintenance of public security cannot be invoked to violate the right to life ... the state must ensure that, if it is necessary to resort to physical means ... members of its armed forces and its security bodies will use only those means that are indispensable to control such situations in a rational and proportional manner, and respecting the rights to life and to humane treatment.” http://www.corteidh.or.cr/docs/casos/articulos/Seriec_95_ing.pdf

¹³ United Nations Congress on the Prevention of Crime and the Treatment of Offenders, “Basic Principles on the Use of Force and Firearms by Law Enforcement Officials,” sec. 13: “In the dispersal of assemblies that are unlawful but nonviolent, law enforcement officials shall avoid the use of force or, where that is not practicable, shall restrict such force to the minimum extent necessary.”

¹⁴ Human Rights Council, “The Promotion and Protection of Human Rights in the Context of Peaceful Protests” (United Nations General Assembly, April 11, 2014), <http://www.ohchr.org/Documents/Issues/Executions/A-HRC-RES-25-38.pdf>

¹⁵ “Global Non-Lethal Weapons Market 2015-2019” (Techinavio, October 2015), <http://www.reportlinker.com/p01911331-summary/Global-Non-lethal-Weapons-Market.html>; “Global Non-Lethal Weapons Market Report 2013 - 2018,” accessed December 15, 2015, <http://www.prnewswire.com/news-releases/global-non-lethal-weapons-market-report-2013---2018-228800551.html>

¹⁶ Neil Corney, Skype, April 24, 2015; Omega Research Foundation and Amnesty International, “The Human Rights Impact of Less Lethal Weapons and Other Law Enforcement Equipment.”

¹⁷ Human Rights Council, “Report of the Special Rapporteur on Extrajudicial, Summary or Arbitrary Executions, Christof Heyns.”

¹⁸ Departmental Task Team, “Briefing on Crowd Control” (Independent Complaints Directorate, Republic of South Africa. Presentation to the Portfolio Committee on Police, Parliament, August 30, 2011), <http://www.icd.gov.za/sites/default/files/Crowd%20Control%20Presentation.pdf>

¹⁹ Omega Research Foundation, “Crowd Control Technologies: An Appraisal of Technologies for Political Control” (Manchester, UK: European Parliament, Directorate General for Research. The STOA Programme, June 2000), http://www.omegaresearchfoundation.org/assets/downloads/publications/19991401a_en.pdf; “Global Non-Lethal Weapons Market Report 2013 -- 2018,” n. Manufacturing of KIPs takes place in locations as diverse as Brazil, China, Israel, South Africa, South Korea, and the United States.

²⁰ Human Rights Watch, Video Shows Police Shot Woman at Protest, website (Egypt, 2015), <http://www.hrw.org/news/2015/02/01/egypt-video-shows-police-shot-woman-protest>

²¹ Holly Atkinson and Richard Sollom, “Weaponizing Tear Gas: Bahrain’s Unprecedented Use of Toxic Chemical Agents Against Civilians” (Boston, MA: Physicians for Human Rights, August 2012), https://s3.amazonaws.com/PHR_Reports/Bahrain-TearGas-Aug2012-small.pdf

²² Ahmad Mahajna et al., “Blunt and Penetrating Injuries Caused by Rubber Bullets during the Israeli-Arab Conflict in October, 2000: A Retrospective Study,” *Lancet* 359, no. 9320 (May 25, 2002): 1795–1800, doi:10.1016/S0140-6736(02)08708-1

²³ D. De Brito et al., “The Injury Pattern of a New Law Enforcement Weapon: The Police Bean Bag,” *Annals of Emergency Medicine* 38, no. 4 SUPPL. (2001): 383–90, doi:10.1067/mem.2001.117272.

²⁴ K. Hubbs, “Less-Lethal Munitions as Extended-Range Impact Weapons,” vol. 2934, 1997, 37–42, doi:10.1117/12.265418.

²⁵ Florian K. P. Sutter, “Ocular Injuries Caused by Plastic Bullet Shotguns in Switzerland,” *Injury* 35, no. 10 (October 2004): 963–67, doi:10.1016/j.injury.2003.11.020; A. Yellin et al., “Penetrating Thoracic Wounds Caused by Plastic Bullets,” *Journal of Thoracic and Cardiovascular Surgery* 103, no. 2 (1992): 381–85; M Mir et al., “Is Use Of Rubber Bullets Justified?,” *Internet Journal of Surgery* 29, no. 1 (2013), <https://ispub.com/IJS/29/1/14477>; T. Lavy and S. Abu Asleh, “Ocular Rubber Bullet Injuries,” *Eye* 17, no. 7 (2003): 821–24, doi:10.1038/sj.eye.6700447.

²⁶ Lavy and Abu Asleh, “Ocular Rubber Bullet Injuries.”

²⁷ Sarit Michaeli, “Crowd Control: Israel’s Use of Crowd Control Weapons in the West Bank,” trans. Shuli Schneiderman (B’Tselem, January 2013).

²⁸ Z.M. Jaouni and J.G. O’Shea, “Surgical Management of Ophthalmic Trauma due to the Palestinian Intifada,” *Eye* 11, no. 3 (1997): 392–97.

- ²⁹ M.L. Wani et al., "Pattern, Presentation and Management of Vascular Injuries due to Pellets and Rubber Bullets in a Conflict Zone," *Journal of Emergencies, Trauma and Shock* 6, no. 3 (2013): n. The authors highlight that "early interventions and prompt resuscitation" are vital to decreasing amputation rates. doi:10.4103/0974-2700.115318.
- ³⁰ "Montenegro aseguró que la Metropolitana actuó bajo el 'protocolo de acción,'" *La Nación*, April 26, 2013, <http://www.lanacion.com.ar/1576582-montenegro-defendio-el-accionar-de-la-metropolitana-en-el-borda>
- ³¹ B. Ballantyne and S. Callaway, "Inhalation Toxicology and Pathology of Animals Exposed to O-Chlorobenzylidene Malononitrile (CS)," *Medicine, Science, and the Law* 12, no. 1 (January 1972): 43–65.
- ³² "Acute Exposure Guidelines Levels (AEGs) for Tear Gas (CS)" (National Advisory Committee for Acute Exposure Guideline Levels for Hazardous Substances, September 2009), http://www.epa.gov/oppt/aegl/pubs/tear_gas_interim_sept_09_v1.pdf
- ³³ Lenhart, *Medical Aspects of Chemical Warfare*, chap. 13.
- ³⁴ Medical News Today, "What Is Pepper Spray? Is Pepper Spray Dangerous?," *Medical News Today*, November 25, 2011, <http://www.medicalnewstoday.com/articles/238262.php>
- ³⁵ "Combined Systems, Inc.," company site, CSI Inc. Supporting Military Forces and Law Enforcement Agencies World-Wide, (April 24, 2015), <https://www.combinedsystems.com/products/?cid=13>
- ³⁶ Olajos and Salem, "Riot Control Agents."
- ³⁷ National Advisory Committee for Acute Exposure Guideline Levels for Hazardous Substances, "Acute Exposure Guidelines Levels (AEGs) for Tear Gas (CS)."
- ³⁸ Ramesh C. Gupta, *Handbook of Toxicology of Chemical Warfare Agents* (Academic Press, 2015).
- ³⁹ Pierre-Nicolas Carron and Bertrand Yersin, "Management of the Effects of Exposure to Tear Gas," *BMJ (Clinical Research Ed.)* 338 (2009): b2283.
- ⁴⁰ Neal Caren, Raj Andrew Ghoshal, and Vanesa Ribas, "A Social Movement Generation Cohort and Period Trends in Protest Attendance and Petition Signing," *American Sociological Review* 76, no. 1 (February 1, 2011): 125–51, doi:10.1177/0003122410395369.
- ⁴¹ John Archer, "Sex Differences in Aggression between Heterosexual Partners: A Meta-Analytic Review," *Psychological Bulletin* 126, no. 5 (2000): 651–80, doi:10.1037/0033-2909.126.5.651.
- ⁴² Philip J. Landrigan, "Children as a Vulnerable Population," *International Journal of Occupational Medicine and Environmental Health* 17, no. 1 (2004): 175–77.
- ⁴³ P. A. Routledge, M. S. O'Mahony, and K. W. Woodhouse, "Adverse Drug Reactions in Elderly Patients," *British Journal of Clinical Pharmacology* 57, no. 2 (February 2004): 121–26, doi:10.1046/j.1365-2125.2003.01875.x.
- ⁴⁴ Umit Unuvar et al., "Medical Evaluation of Gezi Cases- HRFT" (Human Rights Foundation of Turkey, December 2013).
- ⁴⁵ A.M.B. Zekri et al., "Acute Mass Burns Caused by O-Chlorobenzylidene Malononitrile (CS) Tear Gas," *Burns* 21, no. 8 (1995): 586–89, doi:10.1016/0305-4179(95)00063-H.
- ⁴⁶ Richard J. Thomas et al., "Acute Pulmonary Effects from O-Chlorobenzylidenemalonitrile 'Tear Gas': A Unique Exposure Outcome Unmasked by Strenuous Exercise after a Military Training Event," *Military Medicine* 167, no. 2 (February 2002): 136–39.
- ⁴⁷ El Khanka Misdemeanour Court, El Khanka Precinct Administrative Case No. 5144 for the Year 2013 and Court Case No. 15025 for the Year 2014 (Egypt, n.d.).
- ⁴⁸ EIPR, "EIPR statement on the proceedings of the investigation," December 18, 2013, <http://eipr.org/pressrelease/2013/12/18/1904>
- ⁴⁹ EIPR, "The Use of Tear Gas by Egyptian Security Forces in November 2011" (Cairo, Egypt: The Egyptian Initiative for Personal Rights, January 2012), http://eipr.org/sites/default/files/pressreleases/pdf/the_use_of_tear_gas_by_egyptian_security_forces.pdf
- ⁵⁰ Horváth Balázs Szilli Tamás, "Csata a horgosi határon (A battle at the Horgos Border)," *Index*, September 17, 2015, http://index.hu/video/2015/09/17/osszecsapas_roszke/
- ⁵¹ "OSCE Representative Calls on Authorities in Hungary to Ensure the Safety of Journalists Covering the Refugee Crisis," (Vienna: Organization for Security and Co-operation in Europe (OSCE), September 17, 2015), <http://www.osce.org/fom/182646>; "Hungarian Authorities Constantly Infringe the Freedom of the Press," (Budapest, Hungary: Hungarian Civil Liberties Union, September 23, 2015), http://tasz.hu/files/tasz/imce/2015/infringements_of_freedom_of_the_press.pdf
- ⁵² "Growing Controversy Surrounding Migrant Clashes at Hungary's Southern Border -- New Details Emerge," *English*, October 13, 2015, <http://english.atlatzso.hu/2015/10/13/growing-controversy-surrounding-migrant-clashes-at-hungarys-southern-border-new-details-emerge/>

- ⁵³ "White-Washing the Water Cannon: Salesmen, Scientific Experts and Human Rights Abuses," openDemocracy, August 27, 2014, <http://www.opendemocracy.net/opensecurity/anna-feigenbaum/white-washing-water-cannon-salesmen-scientific-experts-and-human-rights>
- ⁵⁴ M.A. Berger, *Seeing through Race: A Reinterpretation of Civil Rights Photography*, (Berkeley: University of California Press, 2011).
- ⁵⁵ Author redacted, "Medical Implications of the Use of Vehicle Mounted Water Cannon (Issue 2.0)," (Defence Science and Technology Laboratory UK, February 2004), 67, https://www.gov.uk/government/uploads/system/uploads/attachment_data/file/445174/040201_DSTL_3_-_Feb_2004_-_TR08591_-_Ready_for_publication.pdf
- ⁵⁶ Turkey Protest, Headshot of a Protester by a Water Cannon!!, YouTube (Turkey, 2013), <https://www.youtube.com/watch?v=dixypDE2Jxw>
- ⁵⁷ "White-Washing the Water Cannon."
- ⁵⁸ Ibid.
- ⁵⁹ Ibid.
- ⁶⁰ Patrick Strickland, "Israel Sprays 'Skunk Water' into Palestinian Homes," *The Electronic Intifada*, September 22, 2014, <http://electronicintifada.net/blogs/patrick-strickland/israel-sprays-skunk-water-palestinian-homes>
- ⁶¹ Dietrich Wagner, "'People of Britain, Beware of the Water Cannon': A Warning from Dietrich Wagner, Near-Blinded in Stuttgart," February 21, 2014, sec. News, <http://www.telegraph.co.uk/news/uknews/law-and-order/10654956/People-of-Britain-beware-of-the-water-cannon-a-warning-from-Dietrich-Wagner-near-blinded-in-Stuttgart.html>
- ⁶² D. Landau and D. Berson, "High-Pressure Directed Water Jets as a Cause of Severe Bilateral Intraocular Injuries," *American Journal of Ophthalmology* 120, no. 4 (October 1995): 542-43.
- ⁶³ Wagner, "'People of Britain, Beware of the Water Cannon.'"
- ⁶⁴ Constanza Hola Chamy, BBC Mundo, "Rodrigo Avilés, El Estudiante En Coma Por El Que Miles Se Movilizan En Chile," BBC Mundo, May 29, 2015, http://www.bbc.com/mundo/noticias/2015/05/150529_rodrigo_aviles_estudiante_coma_chile_ch
- ⁶⁵ Umit Unuvar et al., "Medical Evaluation of Gezi Cases -- HRFT" (Human Rights Foundation of Turkey, December 2013).
- ⁶⁶ Author redacted, "Medical Implications of the Use of Vehicle Mounted Water Cannon (Issue 2.0)."
- ⁶⁷ Turkey Protest, Headshot of a Protester by a Water Cannon!!
- ⁶⁸ Anne Suciu, "Ending the Use of Skunk Spray in East Jerusalem," November 24, 2011, <http://www.acri.org.il/en/wp-content/uploads/2015/05/EJ-Skunk-Spray-Letter-Nov-14.pdf>
- ⁶⁹ Reuters, "Around the World; Frankfurt Police Charge Crowd at Banned Protest," *The New York Times*, October 6, 1985, sec. World, <http://www.nytimes.com/1985/10/06/world/around-the-world-frankfurt-police-charge-crowd-at-banned-protest-crowd.html>
- ⁷⁰ "Stampede in Cambodia Kills Hundreds, Government Says," accessed October 23, 2015, <http://www.cnn.com/2010/WORLD/asiapcf/11/22/cambodia.festival.deaths/index.html?hpt=T2>
- ⁷¹ "Flash Bang Stun Grenades and Their Use in Boston: What You Need to Know," accessed May 7, 2015, <http://thebostonmarathonbombings.weebly.com/flash-bang-stun-grenades-and-their-use-in-boston-what-you-need-to-know.html>; Steve James, "Flash Bang 101," Sponsored by TASER INTERNATIONAL, PoliceOne, (October 21, 2005), <http://www.policeone.com/police-products/tactical/tactical-entry/articles/120100-Flash-Bang-101/>
- ⁷² Steve James, "Flash Bang 101."
- ⁷³ Ibid.
- ⁷⁴ Abbie Nehring et al., "'Less Lethal' Flash-Bangs Used in Ferguson Leave Some Feeling the Burn," ProPublica, accessed January 15, 2016, <http://www.propublica.org/article/less-lethal-flash-bangs-used-in-ferguson-leave-some-feeling-the-burn>
- ⁷⁵ Kaye Beach, "Stun Grenades," AxXiom for Liberty, September 15, 2009, <https://axiomamuse.wordpress.com/tag/stun-grenades/>
- ⁷⁶ Steve James, "Flash Bang 101."
- ⁷⁷ Julia Angwin, Abbie Nehring, and ProPublica, "Hotter Than Lava: Every Day, Cops Toss Flashbang Grenades With Little Oversight and Horrifying Results," ProPublica, accessed May 13, 2015, <http://www.propublica.org/article/flashbangs>
- ⁷⁸ Ibid.
- ⁷⁹ "Commission spéciale d'examen des événements du printemps 2012" (Quebec: Gouvernement du Quebec, March 2014), http://www.securitepublique.gouv.qc.ca/fileadmin/Documents/police/publications/rapport_CSEEP2012/rapport_CSEP2012.pdf

⁸⁰ “Police Stun Grenade Blamed for Student’s Eye Injury,” accessed January 15, 2016, <http://www.cbc.ca/news/canada/montreal/police-stun-grenade-blamed-for-student-s-eye-injury-1.1170655>

⁸¹ “Francis Grenier Poursuit Le SPVM,” *Le Devoir*, accessed January 15, 2016, <http://www.ledevoir.com/societe/justice/358690/francis-grenier-poursuit-le-spvm>

⁸² “Commission spéciale d’examen des événements du printemps 2012” supra note 1 at 300.

⁸³ *Ibid.*

⁸⁴ *Ibid.* 297

⁸⁵ Steve James, “Flash Bang 101.”

⁸⁶ Angwin, Nehring, and ProPublica, “Hotter Than Lava”; Virginia Hennessey and Herald Staff Writer, “Monterey County Agrees to Pay \$2.6 Million in ‘Flash-Bang’ Death of Greenfield Man,” accessed May 7, 2015, <http://www.montereyherald.com/general-news/20130819/monterey-county-agrees-to-pay-26-million-in-flash-bang-death-of-greenfield-man>; Cory Mitchell, “Disquiet Builds Nationwide over Police Flash-Bang Use,” *Star Tribune*, Minneapolis, MN, December 13, 2011, <http://www.startribune.com/disquiet-builds-nationwide-over-police-flash-bang-use/135482398/>; Jack Mirkson, “CNN Crew Hit By Stun Grenades During World Cup Protest In Brazil,” *The Huffington Post*, June 12, 2014, http://www.huffingtonpost.com/2014/06/12/cnn-world-cup-hit-stun-grenades_n_5488451.html

⁸⁷ Angwin, Nehring, and ProPublica, “Hotter Than Lava.”

⁸⁸ Alison Lynn and Matthew Gutman, “Family of Boy Injured by ‘Grenade’ Has \$1M in Medical Bills,” *ABC News*, December 22, 2014, <http://abcnews.go.com/US/family-toddler-injured-swat-grenade-faces-1m-medical/story?id=27671521>

⁸⁹ William K. Rashbaum, “Woman Dies After Police Mistakenly Raid Her Apartment,” *The New York Times*, May 17, 2003, sec. N.Y. / Region, <http://www.nytimes.com/2003/05/17/nyregion/woman-dies-after-police-mistakenly-raid-her-apartment.html>

⁹⁰ Daily Mail Reporter, “Veteran SWAT Officer Killed in His Home after Stun Grenade He Was Safety-Checking Explodes,” *Daily Mail*, February 26, 2011, <http://www.dailymail.co.uk/news/article-1361010/Veteran-SWAT-officer-killed-home-stun-grenade-safety-checking-explodes.html>

⁹¹ LRAD, “LRAD Corporation – PRODUCT OVERVIEW,” accessed May 2, 2015, <http://www.lradx.com/site/content/view/15/110/>

⁹² Mark Thompson, “Is There a Sound Defense Against the Somali Pirates?,” *Time*, November 19, 2009, <http://content.time.com/time/world/article/0,8599,1940536,00.html>

⁹³ LRAD, “LRAD Corporation – PRODUCT OVERVIEW.”

⁹⁴ “Noise and Hearing Loss Prevention,” *The National Institute for Occupational Safety and Health (NIOSH)*, December 5, 2014, <http://www.cdc.gov/niosh/topics/noise/>

⁹⁵ Catherine Farley, “How the Gun Feels,” *Toronto Star*, n.d., <https://meslin.wordpress.com/2010/06/22/bring-the-noise/>

⁹⁶ MST, “Mosquito Device Anti Loitering,” *Moving Sound Technologies*, accessed May 2, 2015, <http://www.movingsoundtech.com/>

⁹⁷ LRAD, “Memorandum: LRAD Corporation’s Position Statement on Product Classification” (LRAD Corporation, April 29, 2014), https://www.uscommunities.org/fileadmin/hb/usc/Suppliers/Safeware_Mallory/LRAD_Position_Statement_121814.pdf

⁹⁸ Ian Urbina, “Protesters Are Met by Tear Gas at G-20 Conference,” *The New York Times*, September 24, 2009, <http://www.nytimes.com/2009/09/25/us/25pittsburgh.html>; Matthew Weaver, “G20 Protesters Blasted by Sonic Cannon,” *The Guardian*, September 25, 2009, sec. World news, <http://www.theguardian.com/world/blog/2009/sep/25/sonic-cannon-g20-pittsburgh>

⁹⁹ ACLU of Pennsylvania, “Piper v. City of Pittsburgh,” 2011, <http://www.aclupa.org/our-work/legal/legaldocket/piper-v-city-pittsburgh-et-al/>

¹⁰⁰ “NYPD Blast LRAD Sound Cannons at OWS,” *RT International*, accessed January 15, 2016, <https://www.rt.com/news/ows-police-sound-cannons-603/>

¹⁰¹ Fuzzytec, “Military Device Used on Detroit Protest against #WaterShutoffs,” *News, Daily Kos*, (July 21, 2014), <http://www.dailykos.com/story/2014/07/21/1315395/-Military-device-used-on-Detroit-protest-against-WaterShutoffs>.

¹⁰² “On the Streets of America: Human Rights Abuses in Ferguson,” *Amnesty International USA*, accessed April 14, 2015, <http://www.amnestyusa.org/research/reports/on-the-streets-of-america-human-rights-abuses-in-ferguson>; “Michael Brown Shooting: What Is the LRAD Sound Cannon Being Used on Ferguson Protesters?,” *International Business Times UK*, accessed January 15, 2016, <http://www.ibtimes.co.uk/michael-brown-shooting-what-lrad-sound-cannon-being-used-ferguson-protesters-1461260>; Lily Hay Newman, “This Is the Sound Cannon Used Against

Protesters in Ferguson,” Slate, August 14, 2014, http://www.slate.com/blogs/future_tense/2014/08/14/lrad_long_range_acoustic_device_sound_cannons_were_used_for_crowd_control.html

¹⁰³ Gothamist, “NYC Cops Are Blithely Firing A Potentially Deafening Sound Cannon At Peaceful Protesters,” Gothamist, accessed January 15, 2016, http://gothamist.com/2014/12/13/lrad_nypd_protests_sound.php

¹⁰⁴ Gideon Orion Oliver and Elena Cohen, “Letter to William Bratton, New York City Police Commissioner from National Lawyers Guild. Re: The NYPD’s Use of Long Range Acoustic Devices for Crowd Control. (December 12, 2014), <https://s3.amazonaws.com/s3.documentcloud.org/documents/1379007/new-york-police-are-asked-to-stop-using-lrad.pdf>

¹⁰⁵ Alex Pasternak, “The New Sound of Crowd Control,” Motherboard, December 17, 2014, <http://motherboard.vice.com/read/the-new-sound-of-crowd-control>

¹⁰⁶ “Acoustic Cannon Sales to Police Surge After Black Lives Matter Protests,” The Intercept, accessed January 15, 2016, <https://theintercept.com/2015/08/14/after-ferguson-baltimore/>

¹⁰⁷ Shane K. Blank, “The Active Denial System: A Legal Review of The U.S. Military’s Latest Non-Lethal Weaponry System” (Law of War, 2012), <http://stabenow.typepad.com/files/active-denial-system.pdf>; “Non-Lethal Weapons Program > About > Frequently Asked Questions > Active Denial System FAQs,” accessed May 7, 2015, <http://jnlwp.defense.gov/About/FrequentlyAskedQuestions/ActiveDenialSystemFAQs.aspx>

¹⁰⁸ Alex and Dorothy Fox, “Less-than-Lethal Active Denial Systems,” Correctional News, February 26, 2014, <http://www.correctionalnews.com/articles/2014/02/26/less-lethal-active-denial-systems>

¹⁰⁹ “Non-Lethal Weapons Program > About > Frequently Asked Questions > Active Denial System FAQs”; Author redacted, “Medical Implications of the Use of Vehicle Mounted Water Cannon (Issue 2.0).”

¹¹⁰ “Non-Lethal Weapons Program > About > Frequently Asked Questions > Active Denial System FAQs.”

¹¹¹ Ibid.

¹¹² Blank, “The Active Denial System: A Legal Review of The U.S. Military’s Latest Non-Lethal Weaponry System.”

¹¹³ “Non-Lethal Weapons Program > About > Frequently Asked Questions > Active Denial System FAQs.”

¹¹⁴ David Nakamura and Niraj Chokshi, “Obama Orders Review of Military Equipment Supplied to Police,” The Washington Post, August 23, 2014, https://www.washingtonpost.com/politics/obama-orders-review-of-military-equipment-supplied-to-police/2014/08/23/6316b8aa-2b03-11e4-8593-da634b334390_story.html

¹¹⁵ Jeff Robertson, Police Shooting Missouri, Photograph, August 11, 2014, <http://www.apimages.com/metadata/Index/Police-Shooting-Missouri/2c4fe90027464450aff042c958f9a2c2/>; “On the Streets of America.”

¹¹⁶ Barbara Starr and Wesley Bruer, “Missouri Guard on Ferguson Protesters: ‘Enemy Forces,’” CNN, April 17, 2015, <http://www.cnn.com/2015/04/17/politics/missouri-national-guard-ferguson-protesters/index.html>

¹¹⁷ Institute of Intergovernmental Research, “After-Action Assessment of the Police Response to the August 2014 Demonstrations in Ferguson, Missouri” (Office of Community Oriented Policing Services, Critical Response Initiative, 2015), <https://assets.documentcloud.org/documents/2328941/after-action-assessment-of-the-police-response.pdf>

¹¹⁸ “Police in Ferguson Are Firing Tear Gas Canisters Manufactured During the Cold War Era,” Truthout, accessed April 14, 2015, <http://www.truth-out.org/news/item/25669-police-in-ferguson-are-firing-tear-gas-canisters-manufactured-during-the-cold-war-era>; Stephen Semler and Peter White, “Less-Lethal Arms & Munitions Documented In Ferguson, Missouri,” Research Report (Australia: Armament Research Services (ARES), April 2015), http://www.armamentresearch.com/wp-content/uploads/2015/05/ARES_Research_Report_4.pdf

¹¹⁹ Jon Swaine, “Michael Brown Protests in Ferguson Met with Rubber Bullets and Teargas,” The Guardian, August 14, 2014, sec. US news, <http://www.theguardian.com/world/2014/aug/14/ferguson-police-teargas-rubber-bullets-michael-brown>

¹²⁰ Wesley Lowery, “Police Use Tear Gas on Crowd in Ferguson, Mo., Protesting Teen’s Death,” The Washington Post, August 12, 2014, <https://www.washingtonpost.com/news/post-nation/wp/2014/08/12/police-use-tear-gas-on-crowd/>

¹²¹ Ibid.

¹²² Semler and White, “Less-Lethal Arms & Munitions Documented In Ferguson, Missouri.”

¹²³ Institute of Intergovernmental Research, “After-Action Assessment of the Police Response to the August 2014 Demonstrations in Ferguson, Missouri.”

¹²⁴ Yasmine Hafiz, "Ferguson Police Reportedly Shot A Female Pastor," The Huffington Post, August 14, 2014, http://www.huffingtonpost.com/2014/08/14/ferguson-pastor-shot-police-rubber-bullet_n_5678973.html

¹²⁵ Nehring et al., "'Less Lethal' Flash-Bangs Used in Ferguson Leave Some Feeling the Burn."

¹²⁶ "On the Streets of America"; Amanda Terkel and Ryan Reilly, "Ferguson Police Fire Tear Gas At Protesters Hours Before Curfew," The Huffington Post, August 17, 2014, http://www.huffingtonpost.com/2014/08/17/ferguson-protests_n_5686601.html

¹²⁷ John Cook, "Intercept Reporter Shot With Rubber Bullets and Arrested While Covering Ferguson Protests," The Intercept, August 19, 2014, <https://theintercept.com/2014/08/19/intercept-reporter-detained-covering-ferguson-protests/>; Ryan Devereaux, "A Night in Ferguson: Rubber Bullets, Tear Gas, and a Jail Cell," The Intercept, August 19, 2014, <https://theintercept.com/2014/08/19/ferguson/>

¹²⁸ Swaine, "Michael Brown Protests in Ferguson Met with Rubber Bullets and Teargas."

¹²⁹ Kimberly Kindy and Wesley Lowery, "Ferguson Police Continued Crackdown on Protesters after Federal, State Interventions," The Washington Post, October 9, 2014, https://www.washingtonpost.com/politics/ferguson-police-continued-crackdown-on-protesters-after-federal-state-interventions/2014/10/09/15df8a2a-4e40-11e4-aa5e-7153e466a02d_story.html

¹³⁰ "On the Streets of America."

¹³¹ Staff, "Ferguson Protest Updates: Hundreds of Arrests across Nation Follow Grand Jury Decision," Los Angeles Times, accessed January 15, 2016, <http://www.latimes.com/nation/nationnow/la-na-nn-ferguson-grand-jury-live-updates-htmlstory.html>

¹³² Runa Sandvik, "Documenting the Arrests of Journalists in Ferguson," Freedom of the Press Foundation, accessed January 15, 2016, <https://freedom.press/blog/2014/08/documenting-arrests-journalists-ferguson>; Ryan Reilly, "On A Night Of Peaceful Protests In Ferguson, One Reporter's Arrest Breaks The Calm," The Huffington Post, accessed January 15, 2016, http://www.huffingtonpost.com/2014/11/23/ferguson-protests_n_6207980.html; Abby Phillip, "Police in Ferguson Arrest and Threaten More Journalists," The Washington Post, August 18, 2014, <https://www.washingtonpost.com/news/post-nation/wp/2014/08/18/police-in-ferguson-arrest-and-threaten-more-journalists/>; Brian Stelter, "6 More Journalists Arrested in Ferguson Protests - CNN.com," CNN, August 19, 2014, <http://www.cnn.com/2014/08/19/us/ferguson-journalists-arrested/index.html>

¹³³ Barack Obama, "Transcript: Obama's Remarks on Unrest in Ferguson, Mo., and Iraq," (Speech, Massachusetts, U.S.A., August 14, 2014), https://www.washingtonpost.com/politics/transcript-president-obamas-remarks-on-unrest-in-ferguson-mo-and-iraq/2014/08/14/c8ce971e-23c7-11e4-958c-268a320a60ce_story.html